



# Goodyear Truck Tyres.

## Technical Data Book

Tyre Range and Application Map

Technical Data

Retread Information

Regrooving Guidelines

Tyre Technology





---

# Contents

<b>Truck Tyre Range and Application Map</b>	4
<hr/>	
<b>Tyre Range</b>	
On Road Fuel Efficient	6
On Road Mileage	12
Mixed Service	20
Offroad	28
Urban	32
Coach	36
Winter	40
<hr/>	
<b>Technical Data</b>	46
<hr/>	
<b>Retread Information and Regrooving Guidelines</b>	58
Retread Information	58
Regrooving Guidelines	62
On Road Fuel Efficient	64
On Road Mileage	66
Mixed Service	69
Offroad	71
Urban	72
Coach	73
Winter	74
<hr/>	
<b>Tyre Technology</b>	76
Tyre construction	78
Tyre terminology	79
Tyre markings	80
Load index and speed symbol	84
Interaction of load and speed	85
Rim and wheels	98
Tubes and flaps	90
Valves	92

# Truck Tyre Range and Application Map



**ON ROAD  
FUEL EFFICIENT**



**ON ROAD  
MILEAGE**



**MIXED SERVICE**

## STEER

**FUELMAX S  
GEN-2**



**KMAX S  
GEN-2**



**KMAX S A**



**OMNITRAC S**



**OMNITRAC S  
HEAVY DUTY**



**FUELMAX S PERFORMANCE  
22.5" 55 series**



**KMAX S  
22.5"**



**KMAX S  
17.5" & 19.5"**



**MSS II  
19.5", 20", 22.5" and 24"**



**LHS II+ 6-rib  
22.5"**



**RHS II  
22.5"**



**MSS  
375/90R22.5 and 445/75R22.5**



## DRIVE

**FUELMAX D  
GEN-2**



**KMAX D  
GEN-2**



**OMNITRAC D**



**OMNITRAC D  
HEAVY DUTY**



**FUELMAX D  
PERFORMANCE**



**KMAX D  
22.5"**



**KMAX D  
17.5" & 19.5"**



**MSD II  
20", 22.5" and 24"**



**LHD  
495/45R22.5**



**RHD II  
22.5"**



**MSD II Super Single 385/55R22.5  
MSD II Super Single 495/45R22.5**



## TRAILER

**FUELMAX T  
22.5"**



**KMAX T  
GEN-2**



**FUELMAX T  
435/50R19.5**



**KMAX T  
19.5" and 22.5"**



**LHT**



**KMAX T LPT  
17.5" & 19.5"**



**OMNITRAC T**





**OFFROAD**



**URBAN**



**COACH**



**WINTER**

**ORS**  
22.5"



**ORD**  
14.00R20



**ORD**  
22.5" and 24"



**ORD**  
365/85R20 and 375/90R22.5



**UrbanMax MCS**  
22.5"



**UrbanMax MCA**  
19.5" and 22.5"



**UrbanMax MCA**  
19.5" and 22.5"



**UrbanMax MCD Super Single**  
22.5"



**UrbanMax MCD \* Traction**  
22.5"



**Marathon Coach**  
22.5"



**Marathon Coach**  
22.5"



**ULTRA GRIP Coach**  
22.5"

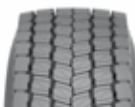

**ULTRA GRIP MAX S**  
22.5"



**UltraGrip WTS 5-rib**  
22.5"



**UltraGrip WTS 6-rib**  
22.5"



**ULTRA GRIP MAX D**  
22.5"



**UltraGrip WTD**  
22.5"



**ULTRA GRIP MAX T**  
22.5"



**UltraGrip WTT**  
19.5"



## LEGEND



**M+S (Mud and Snow)** indicates that a tyre has better snow traction than a regular tyre (see details on page 82)



**3PMSF (Three Peak Mountain Snowflake)** indicates that a tyre has passed a minimum performance threshold requirement on snow (see details on page 82)



**TreadMax retreads** are produced exclusively in-house and utilise the same casing, tread pattern and materials as new tyres – resulting in a similar to new tyre performance (see details on page 60)



**FRT (Free Rolling Tyre)** indicates that the tyre should only be fitted to free rolling axles, such as trailer applications (see details on page 82)



An **RFID tag (Radio Frequency Identification)** is embedded inside the tyre and allows simple identification and connectivity to tyre management and tracking systems. The RFID contains ISO standard information as per SGTIN96 coding.



# On Road Fuel Efficient Tyre Range.



Tyre Range



# FUELMAX S GEN-2



The FUELMAX S GEN-2 range provides optimal fuel efficiency as well as allowing fleets to face the multiple challenges they might find on their daily route.

It features IntelliMax Rib Technology that offers high mileage and precise steering with deep Flexomatic sipes for wet and winter braking. FUELMAX GEN-2 tyres are marked with the Three Peak Mountain Snowflake to fulfil the most stringent winter regulations.



- Wide open shoulder grooves: Open grooves facilitate water evacuation – Improved wet grip
- Deep “Flexomatic” sipes: “Flexomatic” sipes close when rolling through the footprint allowing the tread blocks to interlock, making the tread stiffer – Short braking distances combined with optimal fuel efficiency and high mileage
- IntelliMax Rib Technology: Stiffer bridges connect when the tyre rolls making the tread stiffer and limiting slip – Very precise steering and high mileage
- Regular footprint pressure distribution: Results in even wear over the tyre life – Regular wear until the end of the tyre life, high mileage in a wide range of applications and load conditions

## Technical Data



Size	Load Index	Speed Symbol	Comments	
295/80R22.5	154/149	M	High Load version	B C 70 )
315/80R22.5	156/150 (154/150)	L (M)		B B 72 )))
315/70R22.5	156/150	L	High Load version	B B 70 )
385/65R22.5	160 (158)	K (L)		B B 70 )

Size	Load Index	Speed Symbol	Comments	
295/60R22.5	150/147 (149/146)	K (L)		B C 71 )
315/60R22.5	154/148	L	High Load version	Under development
385/55R22.5	160 (158)	K (L)		B B 71 )
355/50R22.5	156 (152)	K (L)	High Load version	Under development
375/50R22.5	156	K		Under development

# FUELMAX D GEN-2



The FUELMAX D GEN-2 drive axle tyre offers high fuel saving potential through optimised rolling resistance in a well balanced package for inter-regional and long haul applications. It features excellent traction with improved all-weather capabilities throughout the tyre life and fulfils all new and already adopted winter regulations.



- High density, full depth tread siping: Sipes go down to 100% of tread depth for increased biting edge length, throughout the full tyre life – Life long traction in all road surface conditions; good wet braking performance; 3PMSF
- Large shoulder grooves: Openings in the shoulder ribs create biting edges for increased traction and effectively evacuate water and mud – High traction throughout complete tyre life
- IntelliMax Groove Technology: Hidden raindrop shaped centre grooves close when rolling through the footprint. The ribs support each other, stiffening the tread – Low rolling resistance
- Tread depth measuring windows in IntelliMax grooves: 16 measuring windows placed in the tread provide openings to the bottom of the IntelliMax grooves – Full depth visibility and easy measurement at any location around the tyre
- Fuel saving, high abrasion resistant tread compound: The compound ensures cool running capabilities. Strong links in the polymer network provide high abrasion resistance – Low rolling resistance; excellent wear resistance; high mileage potential
- Regular footprint pressure distribution: The new design and casing shape avoids irregular wear – Regular treadwear and high mileage potential

## Technical Data



Size	Load Index	Speed Symbol	Comments	
295/80R22.5	152/148	M		C B 73 )  TreadMax
315/80R22.5	156/150 (154/150)	L (M)		B C 73 )  TreadMax

Size	Load Index	Speed Symbol	Comments	
315/70R22.5	154/148 (152/148)	L (M)		B B 73 )  TreadMax
295/60R22.5	150/147 (149/146)	K (L)		Under development
315/60R22.5	152/148	L		B C 73 )  TreadMax



# FUELMAX S PERFORMANCE



The new FUELMAX S PERFORMANCE steer axle tyre is optimised for maximum fuel efficiency in long haul applications. It features extra low rolling resistance and contributes to lowering CO<sub>2</sub> emissions.

However, it offers full 3PMSF winter legislation compliance and maintains a high level of control in daily use.



- Innovative full silica tread: Chemical formulation and polymer network for new levels of rolling resistance and wet grip – Low fuel consumption and heat generation combined to excellent wet grip
- Deep siping: Sipes go down to 70% of tread depth and maintain biting edges – 3PMSF capability and good wet braking performance throughout the tyre life
- Optimised groove distribution: Even pressure distribution in the footprint, improved water evacuation – Wet grip and regular wear
- Optimised footprint: Even pressure distribution in the road contact area – Regular tread wear in long haul applications and precise handling

## Technical Data



Size	Load Index	Speed Symbol	Comments			
315/70R22.5	156/150	L	High Load version, RFID	B	B	71 )

Size	Load Index	Speed Symbol	Comments			
385/55R22.5	160 (158)	K (L)	RFID	A	C	70 )

# FUELMAX D PERFORMANCE



The new FUELMAX D PERFORMANCE drive axle tyre is optimised for maximum fuel efficiency in long haul applications. It features extra low rolling resistance and contributes to lowering CO<sub>2</sub> emissions.

In addition, it offers full 3PMSF winter legislation compliance and a high level of traction throughout the tyre life.



- Innovative full silica tread: Chemical formulation and polymer network for new levels of rolling resistance and wet grip – Lower fuel consumption and shorter braking distances
- Deep siping: Sipes go down to 70% of tread depth and maintain biting edges – Life long traction and good wet braking performance; 3PMSF marking
- Regular footprint pressure distribution: Even wear in long haul highway service – Long life wear quality, high mileage potential
- IntelliMax Groove Technology: IntelliMax grooves open when 50% worn creating additional grip and drainage capabilities in late tyre life – High mileage potential, even wear

## Technical Data



Size	Load Index	Speed Symbol	Comments			
315/70R22.5	154 (152)	L (M)	RFID	A	C	73 )

# FUELMAX T 19.5" and 22.5"



The FUELMAX T features a multi-radius cavity and a special tread compound offering ultra low rolling resistance for excellent fuel saving combined with improved mileage performance, good braking in wet conditions and low noise emissions.

The new bead geometry in combination with modern high tensile cord material creates a highly robust casing structure for improved retreadability and extended tyre life.



M+S  
FRT

- Specific silica-rich tread compound: High mileage potential and good wet grip – Combination of wet grip, low rolling resistance and high mileage potential
- Complex multi-radius cavity: optimised pressure distribution in the footprint, high wearable tread volume – Even wear, exceptional low rolling resistance, excellent fuel saving potential
- Wide and solid shoulder ribs: Highly resistant against shoulder wear, reduces irregular wear in pure long haul use – Extended tyre life, improved stability and handling

## Technical Data



Size	Load Index	Speed Symbol	Comments		
435/50R19.5	160	J		A C 73 ))	
435/50R19.5	164	J	High Load version	A C 70 ))	

Size	Load Index	Speed Symbol	Comments		
385/65R22.5	164 (158)	K (L)	High Load version	A C 69 ))	
385/55R22.5	160 (158)	K (L)		A C 70 ))	

# Marathon LHS II 22.5"



Marathon LHS II features a dedicated tread compound using the Sileflex technology designed to lower the fuel consumption and emissions while keeping wet grip performance and mileage potential at a premium level.



- Wide tread, 6 rib for excellent mileage, even wear and good handling/stability
- "Flexomatic Blades" and "Edge Blading" on grooves for excellent braking on wet, even wear and high mileage
- Latest technology carcass geometry and materials for reduced weight, enhanced damage resistance, durability and retreadability
- Low rolling resistance

## Technical Data



Size	Load Index	Speed Symbol	Comments		
375/50R22.5	156	K		B B 71 ))	

# Marathon LHD 495/45R22.5



Marathon LHD features a dedicated tread compound using the Sileflex technology designed to lower the fuel consumption and emission while keeping good wet traction performance and mileage potential at a premium level.



- Wide tread with large shoulder ribs for excellent mileage, traction and braking as well as even wear pattern
- “3D-BIS” waffle blade technology for traction and braking performance and improved handling and stability
- Latest technology carcass geometry and materials for reduced weight, enhanced damage resistance, durability and retreadability

## Technical Data



Size	Load Index	Speed Symbol	Comments	
495/45R22.5	169	K		C C 72 )

# Marathon LHT, LHT+ and LHT II



The Marathon LHT has been developed to support fleet efficiency and reduce cost per km. It features super low rolling resistance combined to improved mileage performance, good braking on wet and low noise emissions. Additional payload through reduced tyre weight is another feature of the marathon trailer tyres.



- Fuel savings
- Excellent mileage
- Good braking on wet
- Increased payload
- Good durability and retreadability

## Technical Data



Size	Load Index	Speed Symbol	Comments	
11R22.5	148/145 (146/143)	J (L)	Marathon LHT	C C 68 )
275/70R22.5	152/148 (148/145)	J (L)	Marathon LHT II	C C 70 )

Size	Load Index	Speed Symbol	Comments	
435/50R22.5	164	J	Marathon LHT	B D 70 )
455/40R22.5	160	J	Marathon LHT+	C C 72 )

## LEGEND



**M+S (Mud and Snow)** indicates that a tyre has better snow traction than a regular tyre (see details on page 82)



**3PMSF (Three Peak Mountain Snowflake)** indicates that a tyre has passed a minimum performance threshold requirement on snow (see details on page 82)



**TreadMax retreads** are produced exclusively in-house and utilise the same casing, tread pattern and materials as new tyres – resulting in a similar to new tyre performance (see details on page 60)



**FRT (Free Rolling Tyre)** indicates that the tyre should only be fitted to free rolling axles, such as trailer applications (see details on page 82)



An **RFID tag (Radio Frequency Identification)** is embedded inside the tyre and allows simple identification and connectivity to tyre management and tracking systems. The RFID contains ISO standard information as per SGTIN96 coding.



# On Road Mileage Tyre Range.



**GOODYEAR**

# KMAX S GEN-2



The new KMAX S GEN-2 steer axle tyre is adapted to the requirements of changing load conditions on a wide range of roads and applications. Featuring the IntelliMax Rib Technology and Flexomatic Sipes for excellent traction and short braking distances throughout the tyre life. A cool running and high abrasion resistant tread compound provides excellent mileage and high fuel efficiency.

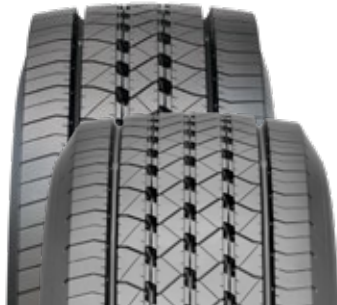

- Proven IntelliMax Rib Technology: Stiffer bridges in the centre grooves connect when the tyre rolls through the footprint, creating a stiffer design and limiting wear – Precise handling, top class mileage.
- Deep “Flexomatic” sipes: “Flexomatic” sipes close when rolling through the footprint so that the tread blocks interlock, making the tread stiffer – Short braking distances throughout tyre life, high mileage; 3PMSF capability combined with low rolling resistance.
- Cool running/high abrasion resistant tread compound: The chemical formulation and polymer network ensure a low rolling resistance combined to excellent treadwear performance – High mileage and fuel efficiency.
- Optimised casing shape: Provides a constant and regular footprint in a wide range of load conditions and throughout the entire tyre life – Regular tread wear over the full tyre life, especially in the shoulders, providing top class mileage.

## Technical Data



Size	Load Index	Speed Symbol	Comments	
295/80R22.5	154/149	M	High Load version	C B 74 )
315/80R22.5	156/150 (154/150)	L (M)		C B 71 )
315/80R22.5	158/150	L	High Load version Under development	
315/70R22.5	156/150	L	High Load version	C B 72 )
295/60R22.5	150/147 (149/146)	K (L)		C B 71 )

Size	Load Index	Speed Symbol	Comments	
315/60R22.5	154/148	L	High Load version	C C 74 )
385/65R22.5	160 (158)	K (L)		B B 70 )
385/55R22.5	160 (158)	K (L)		B B 71 )
355/50R22.5	156	K	High Load version Under development	
375/45R22.5	156	L	Under development	

# KMAX D GEN-2



The new KMAX D GEN-2 drive axle tyre is specifically adapted to the requirements of changing load conditions in a variety of applications. Featuring a density array of deep sipes and grooves for excellent traction throughout the full tyre life. The dual tread compound and regular footprint pressure distribution provides excellent mileage and high fuel efficiency.



- High density and increased depth of sipes and grooves; 6% more length of biting edges until end of life interlocking with the road surfaces – Increased traction and high removal mileage.
- Dynamic stone ejecting design: Grooves open under torque releasing trapped stones and avoiding drilling into the casing – Improved casing protection and tyre durability.
- Large shoulder grooves: Openings in the shoulder ribs create biting edges for increased traction and effectively evacuate water and mud – High traction throughout complete tyre life.
- Dual tread compound, combining two layers of different rubber: The top compound provides high abrasion resistance. The base compound offers low rolling resistance – High mileage combined with fuel efficiency.
- Regular footprint pressure distribution: The KMAX D GEN-2 Casing has been adapted and shows a stable contact pressure over the tyre life – High mileage in a wide range of applications and load conditions; regular wear until end of tyre life.

## Technical Data



Size	Load Index	Speed Symbol	Comments	
295/80R22.5	152/148	M		D C 72 )
315/80R22.5	156/150 (154/150)	L (M)		D C 72 )
315/70R22.5	154/150 (152/148)	L (M)		C B 72 )
295/60R22.5	150/147 (149/146)	K (L)	Under development	

Size	Load Index	Speed Symbol	Comments	
315/60R22.5	152/148	L		D B 73 )
295/55R22.5	147/145	K		C B 72 )
315/45R22.5	147/145	L	Under development	

# KMAX S 22.5"



Up to 30% more mileage compared to its predecessor\*. Thanks to its computer modeled tread profile for optimised tyre pressure distribution, the KMAX S tyre offers regular wear, high mileage, robustness, good braking on wet and excellent handling.



- IntelliMax Rib Technology: Stiffer tread. High mileage and regular wear
- Wide tread, optimised foot print. High mileage
- Robust, wide shoulders. Improved robustness
- Specific blading frequency and geometry. Excellent braking on wet

\*Comparative tests made by Goodyear Innovation Centre Luxembourg on size 315/80R22.5 between July 2011 and June 2013 show that Goodyear KMAX S and KMAX D steer and drive tyres offer an improvement in mileage potential of up to 30% and 35% respectively vs. Goodyear RHS II and RHD II+ tyres.

## Technical Data



Size	Load Index	Speed Symbol	Comments	
295/80R22.5	154/149	M	High Load version	C B 74 ))
275/70R22.5	148/145	M		C B 72 ))
305/70R22.5	153/150 (150/148)	L (M)		C B 71 )
315/60R22.5	154/148	L	High Load version	C B 71 ))

Size	Load Index	Speed Symbol	Comments	
355/50R22.5	156	K	High Load version	C B 71 )
375/45R22.5	156	L		B B 73 ))

# KMAX D 22.5"



Up to 35% more mileage compared to its predecessor\*. The KMAX D offers high mileage potential, high traction performance and low noise emission thanks to optimised tyre pressure distribution, the right number of pitches, the non-skid optimised block geometry and a higher wearable rubber volume compared to its predecessors. The KMAX D also meets established winter requirements carrying both the M+S and the 3 Peak Mountain Snow Flake symbol.



- High Net-to-Gross ratio. Improved rolling resistance and higher mileage
- Extra wide tread width. Better rolling resistance and mileage
- Increased Non-skid depth. Improved mileage
- Directional V-shape tread design. Better traction and noise
- Flexomatic blades. Improved mileage, traction and handling

\*Comparative tests made by Goodyear Innovation Centre Luxembourg on size 315/80R22.5 between July 2011 and June 2013 show that Goodyear KMAX S and KMAX D steer and drive tyres offer an improvement in mileage potential of up to 30% and 35% respectively vs. Goodyear RHS II and RHD II+ tyres.

## Technical Data



Size	Load Index	Speed Symbol	Comments	
275/70R22.5	148/145	M		D C 73 )
305/70R22.5	153/150 (150/148)	L (M)		D C 71 )

Size	Load Index	Speed Symbol	Comments	
295/55R22.5	147/145	K		C B 72 )
315/45R22.5	147/145	L		D C 72 )

# KMAX S A



355/50R22.5 is a size subject to intense strain requiring extra robustness.

The new KMAX S A is an improved version of KMAX S, featuring increased robustness and 3PMSF marking.



- Increased pitch number
- Optimised siping
- Stiffeners in shoulder grooves
- Optimised footprint
- Redistributed rib distribution
- Better robustness in a wide range of load conditions
- 3PMSF marking and winter performance



## Technical Data



Size	Load Index	Speed Symbol	Comments	
355/50R22.5	156	K	High Load version	C B 71 )

# KMAX T GEN-2



The new KMAX T GEN-2 trailer tyre is designed for excellent mileage under all-season conditions and for various types of roads and applications.

It features the 3PMSF marking for full compliance with the latest and future winter tyre requirements. Deep sipes provide short braking distances and improved wet grip throughout tyre life. The robust tread design results in enhanced damage and wear resistance.



- 5-rib tread design with 385/65R22.5 (6- and 7-rib with other sizes): Optimised rib layout to ensure even contact pressure distribution and shoulder robustness with all tyre sizes – Damage and wear resistance for high mileage and long service life under severe conditions
- Deep sipes down to 2/3 of the full tread depth: Sipes create additional biting edges to interlock with the road surface until late life – 3PMSF marking; compliance with most restrictive winter legislations; short braking distances and improved wet grip throughout tyre life; no compromise on other performance criteria
- IntelliMax groove blade design: Teardrop shaped bottom blade design to avoid groove cracking in high scrubbing trailer applications – Robust tread design in demanding applications; high removal mileage
- Cool running/high abrasion resistant tread compound: The chemical formulation and polymer network provide low rolling resistance and excellent resistance against treadwear and lateral scrubbing – High mileage and fuel efficiency



## Technical Data



Size	Load Index	Speed Symbol	Comments	
435/50R19.5	160	J	RFID	Under development
445/45R19.5	160	J		Under development
385/65R22.5	164 (158)	K (L)	RFID, High Load	C B 72 )
425/65R22.5	165	K	RFID	Under development

Size	Load Index	Speed Symbol	Comments	
445/65R22.5	169	K	RFID	Under development
385/55R22.5	160 (158)	K (L)	RFID	Under development



# KMAX T 19.5" and 22.5"



KMAX T offers superb mileage performance thanks to multi radius cavity shape and high wearable rubber volume associated to an innovative tread compound which also resists to groove cracking and tread chunking.



- Improved casing and tuned footprint. Improved mileage performance
- Innovative tread compound. Fuel saving potential
- High wearable rubber volume. Excellent Mileage potential
- Reduced stone holding. Resistance to groove cracking
- Improved edge blades. Excellent braking on wet

## Technical Data



Size	Load Index	Speed Symbol	Comments	Tread Pattern		M+S	RFID	TreadMAX
435/50R19.5	160	J	RFID	B	C 73 )	(M+S)		
385/65R22.5	164 (158)	K (L)	High Load version	B	C 71 )	(M+S)		

Size	Load Index	Speed Symbol	Comments	Tread Pattern		M+S	RFID	TreadMAX
425/65R22.5	165	K		B	B 72 )	(M+S)		
445/65R22.5	169	K		B	B 72 )	(M+S)		
385/55R22.5	160 (158)	K (L)		B	B 71 )	(M+S)		

# KMAX S 17.5" and 19.5"



The new KMAX S tyres provide operators with excellent robustness, versatility, handling precision and all weather capability.

The new special tread compound offers high mileage and optimised fuel efficiency, while at the same time, proven IntelliMax Rib Technology provides high stability throughout the life of the tyre and in all applications.



- Solid shoulder ribs: Limited rib movement – Even shoulder wear
- High Net-To-Gross Ratio: High wearable tread volume – High mileage
- IntelliMax Rib Technology: Stiffer bridges connect when tyre rolls, increasing rigidity and limiting slip – Precise steering
- Multi-radius saw tooth shoulder groove: Additional edges provide extra grip – Life-long grip on wet and slippery roads

## Technical Data



Size	Load Index	Speed Symbol	Comments	Tread Pattern		M+S	RFID	TreadMAX
205/75R17.5	124/122	M		D	B 69 )	(M+S)		
215/75R17.5	128/126	M	High Load version	C	B 69 )	(M+S)		
225/75R17.5	129/127	M		D	B 69 )	(M+S)		
235/75R17.5	132/130	M		D	B 69 )	(M+S)		
245/70R17.5	136/134	M	4-rib design	D	B 70 )	(M+S)		
265/70R17.5	139/136	M	4-rib design	C	B 69 )	(M+S)		

Size	Load Index	Speed Symbol	Comments	Tread Pattern		M+S	RFID	TreadMAX
245/70R19.5	136/134	M		D	C 71 )	(M+S)		
265/70R19.5	140/138	M		D	B 71 )	(M+S)		
285/70R19.5	146/144 (144/142)	L (M)		D	C 71 )	(M+S)		

# KMAX D 17.5" and 19.5"



The new KMAX D tyre provides optimal mileage and traction throughout the entire life combined with robustness, all weather capability and versatility. Suitable for all applications and most modern vehicle technologies.

The directional tread pattern with in depth sipes offers great traction on all surfaces throughout the entire tyre life while shoulder tie bars reinforce the tyre tread to cope with high torque conditions.



- Directional pattern: Evacuates water, mud and snow – High traction
- Open grooves and in depth sipes: Creates additional biting edges – Traction through the entire tyre life
- Shoulder tie bar: Reinforced shoulder areas – Even shoulder wear
- Progressive centerline humps: Limits block movements and wear – Optimal mileage and traction

## Technical Data



Size	Load Index	Speed Symbol	Comments	
205/75R17.5	124/122 (126/124)	M (G)		D C 74 )
215/75R17.5	126/124	M		D C 71 )
225/75R17.5	129/127	M		D C 73 )
235/75R17.5	132/130	M		D B 71 )
245/70R17.5	136/134	M		D B 71 )
265/70R17.5	139/136	M		D B 71 )

Size	Load Index	Speed Symbol	Comments	
245/70R19.5	136/134	M		D B 72 )
265/70R19.5	140/138	M		D B 72 )
285/70R19.5	146/144 (144/142)	L (M)		D C 71 )

# Regional RHS II 22.5"



The regional haul steer generation tyre coping with the demanding requirements of modern regional haul service, dedicated for high mileage and a wide application range. The combination of a specifically developed tread pattern with an innovative high silica content tread compound results in excellent mileage performance, excellent wet braking, even wear and reduced rolling resistance.



- Wide tread, 5 rib pattern, groove edge blading, for excellent mileage, even wear and superb handling and stability
- High density, flexomatic blading, for outstanding braking on wet surfaces combined with high mileage
- Advanced technology, high silica tread compound, for high mileage combined with reduced rolling resistance, good tear and damage resistance

## Technical Data



Size	Load Index	Speed Symbol	Comments	
11R22.5	148/145 (146/145)	L (M)		C B 69 )
12R22.5	152/148	L		C B 70 )

Size	Load Index	Speed Symbol	Comments	
13R22.5	156/150 (154/150)	L (M)		D C 70 )
385/65R22.5	164 (158)	K (L)	High Load version	B B 71 )

# Regional RHD II 22.5"



The regional haul drive generation tyre coping with the demanding requirements of modern regional haul service. The tyre is designed for high mileage and a wide application range and features KMax Technology developed to increase mileage performances without compromising other tyre characteristics.

RHD II brings a further improvement in mileage, handling and wear type thanks to a tuned tread pattern configuration. It suits a wide application range, from long haul to local delivery.



- Wide tread, 5 rib directional pattern, for excellent mileage, even wear and superb handling and stability
- Special, directional groove tapers, highly bladed pattern, for improved wet braking and mileage performances, excellent traction and winter grip
- New technology, high silica tread compound, for high mileage combined with good tear and damage resistance
- Dedicated carcass geometry, latest technology carcass materials resulting in enhanced robustness, durability and retreadability

## Technical Data



Size	Load Index	Speed Symbol	Comments	
11R22.5	148/145	L		D C 78 )))
12R22.5	152/148	L		D C 76 ))

Size	Load Index	Speed Symbol	Comments	
13R22.5	156/150 (154/150)	L (M)		D C 78 )))

# KMAX T 17.5" & 19.5"



The KMAX T 17.5 range is the ideal choice for low platform application. Thanks to its tread design and robust construction these tyres offer all season mobility (confirmed by M+S and Three Peak Mountain Snow Flake) combined with optimal mileage and robustness even in demanding low platform usage.



- 4 rib tread design: Even pressure distribution / Robustness
- Radial and longitudinal sipes: Increased grip on wet and snow
- Special tread compound: High mileage potential

## Technical Data



Size	Load Index	Speed Symbol	Comments	
215/75R17.5	135/133	J		C B 67 )
235/75R17.5	143/141 (144/144)	J (F)		C B 70 )
245/70R17.5	143/141 (146/146)	J (F)		B B 70 )
205/65R17.5	129/127 (132/132)	K (G)		C B 71 )

Size	Load Index	Speed Symbol	Comments	
245/70R19.5	141/140	J		C B 69 )
265/70R19.5	143/141	J		C B 70 )
285/70R19.5	150/148	J		B B 70 )
265/55R19.5	141/140 (142/142)	J (G)		C B 71 )

## LEGEND



**M+S (Mud and Snow)** indicates that a tyre has better snow traction than a regular tyre (see details on page 82)



**3PMSF (Three Peak Mountain Snowflake)** indicates that a tyre has passed a minimum performance threshold requirement on snow (see details on page 82)



**TreadMax retreads** are produced exclusively in-house and utilise the same casing, tread pattern and materials as new tyres – resulting in a similar to new tyre performance (see details on page 60)



**FRT (Free Rolling Tyre)** indicates that the tyre should only be fitted to free rolling axles, such as trailer applications (see details on page 82)



An **RFID tag (Radio Frequency Identification)** is embedded inside the tyre and allows simple identification and connectivity to tyre management and tracking systems. The RFID contains ISO standard information as per SGTIN96 coding.



# Mixed Service Tyre Range.



# OMNITRAC S



The new OMNITRAC S steer axle tyre is designed to cope with the specific characteristics for tyres used in modern construction applications.

It features very good on-road wear performance, significantly improved resistance to tread damage and excellent retreadability thanks to the innovative DURASHIELD technology.



- Robust 5 rib design (24" = 4 rib): durability and ground pressure distribution – High mileage and even wear performance
- Siped tread blocks and zig-zag grooves: Sipes double the number of biting edges; zig-zag grooves provide extra grip – 3PMSF-marking on all sizes & wheel positions, improved traction on driven steer axles (hydro-drive)
- 'Quick release' groove shapes with stone penetration protectors . Reduces stone holding; efficient protection against stone drilling and groove cracking – Excellent self cleaning capabilities, improved casing durability, high mileage potential
- Cool running cap & base compound: Increased undertread gauge & tear resistant base compound – High mileage and casing durability; protection against stone damages
- Durashield technology: Polyester top belt for ultimate casing protection against corrosion – New level of casing durability and retreadability performance

## Technical Data



Size	Load Index	Speed Symbol	Comments	
13R22.5	156/150	K		C B 71 )
295/80R22.5	152/148	K		D B 71 )
315/80R22.5	156/150	K		D B 73 )

Size	Load Index	Speed Symbol	Comments	
315/70R22.5	156/150	K	High Load version	Under development
385/65R22.5	160 (158)	K (L)		C B 72 )
325/95R24	162/160	K		C B 72 )

# OMNITRAC D



The new OMNITRAC D drive axle tyre is adapted to the characteristics needed for tyres used in modern construction segments. It features very good on-road wear performance, excellent traction on all surfaces, a longer tyre life and improved retreadability through significantly enhanced resistance to tread damage thanks to the innovative DURASHIELD technology.



- Directional 3-rib tread design with siped blocks: Sipes double the number of biting edges – 3PMSF-marking on all sizes, high traction and even wear on all surfaces including retarder operation
- High centerline net contact area with tie bars: The massive center rib offers high damage resistance – Even wear in abrasive road conditions, high mileage potential and casing durability
- Wide open shoulder grooves with stone penetration protectors: Excellent mud drainage and stone rejection, retains high traction level when worn – High traction throughout complete tyre life and with all carriageway conditions
- Cool running, abrasion resistant cap & base tread compound: Increased undertread gauge & tear resistant base compound – High mileage and casing durability; reduced treadwear in light mixed service
- Durashield technology: Polyester top belt for ultimate casing protection against corrosion – New level of casing durability and retreadability performance

## Technical Data



Size	Load Index	Speed Symbol	Comments	
13R22.5	156/150	K		D B 75 )
295/80R22.5	152/148	K		D B 75 )

Size	Load Index	Speed Symbol	Comments	
315/80R22.5	156/150	K		D B 75 )
315/70R22.5	154 (152)	K (M)	Under development	

# OMNITRAC S HEAVY DUTY



The new OMNITRAC S HEAVY DUTY steer axle tyre is designed to cope with the demanding requirements for tyres in severe mixed service applications.

It features very good on- and off-road wear performance, significantly improved tread resistance to chipping and chunking and excellent retreadability thanks to the innovative DURASHIELD technology.



- Durashield technology: Top belt prevents objects from penetrating the belt package and protects the casing from corrosion – New level of casing durability and retreadability performance
- 4-rib design: Robust tread design with massive shoulder ribs to resist the most demanding mixed service applications – High mileage and even wear performance without chunking
- ‘Quick release’ groove shapes and centerline stone ejectors: Trapped stones are quickly released by the tread movements and centerline stone ejectors prevent them from reaching the groove bottom -> Excellent protection against stone damage leading to less punctures and more casing durability, excellent self cleaning in all terrains for good traction
- High chip and chunk resistance tread compound with increased undertread rubber gauge: A new tread rubber particularly designed to resist to chipping and chunking in all tyre life phases provides high mileage. Increased undertread rubber provides extra protection – High overall mileage and resistance to chipping and chunking. Improved retreadability through better casing protection.

## Technical Data



Size	Load Index	Speed Symbol	Comments	
12R22.5	152/148	K	C B 71 ) M+S	
13R22.5	156/150	K	C B 72 )) M+S	

Size	Load Index	Speed Symbol	Comments	
315/80R22.5	156/150	K	C B 73 )) M+S	
325/95 R 24	162/160	K	Under development M+S	

# OMNITRAC D HEAVY DUTY



The new OMNITRAC D HEAVY DUTY drive axle tyre is designed for the demanding requirements in severe mixed service applications. It features excellent traction and self cleaning, significantly enhanced resistance to chipping and chunking, very good off-road wear performance, and improved retreadability thanks to the innovative DURASHIELD technology.



- Durashield technology: Top belt prevents objects from penetrating the belt package and protects the casing from corrosion – Ultimate corrosion protection of the tyre casing, new level of casing durability and retreadability performance
- Directional tread design with siped blocks: Directional tread design ensures traction and self cleaning until the end of the tread life – Traction in all surface conditions including winter service
- Continuous tractive centerline design: The robust tractive centerline provides traction and concurrently protects the tread against damages in its most vulnerable zone – Even wear in chipping and chunking conditions, high mileage potential and casing protection
- Wide open shoulder grooves and dynamic block design: The V shaped directional design of the blocks provides edges for traction and ejects stones and mud quickly – High traction throughout complete tyre life and with all carriageway conditions; chip/chunk resistance under torque and stone damage prevention
- High chip and chunk resistance tread compound with increased undertread rubber gauge: A new tread rubber particularly designed to resist to chipping and chunking in all tyre life phases provides high mileage. Increased undertread rubber provides extra protection. – High overall mileage and resistance to chipping and chunking. Improved retreadability through better casing protection.

## Technical Data



Size	Load Index	Speed Symbol	Comments	
12R22.5	152/148	K	D B 74 )) M+S	
13R22.5	156/150	K	D B 75 )) M+S	

Size	Load Index	Speed Symbol	Comments	
315/80R22.5	156/150	K	D B 75 )) M+S	
325/95 R 24	162/160	K	Under development M+S	

# Omnitrac MSS II



The Goodyear Omnitrac MSS II features a wide tread, 4-rib and 5-rib pattern for excellent mileage and even wear, combining latest technology materials and design features. Its robust tread pattern provides high mileage in on road use and good damage resistance. The specific groove layouts ensure good self cleaning and reduced stone holding.



- Excellent mileage, even wear pattern
- Improved on/off road braking
- Good damage resistance and stability
- Reduced stone holding/drilling, good self cleaning
- Excellent durability and retreadability

## Technical Data



Size	Load Index	Speed Symbol	Comments	
265/70R19.5	143/141 (140/138)	J (L)		D B 71 )) <b>(M+S)</b>
12.00R20	154 /150	K		C B 71 )) <b>(M+S)</b>
12R22.5	152/148	K		C B 70 )) <b>(M+S)</b>
275/70R22.5	148 /145	K		D B 72 )) <b>(M+S)</b>

Size	Load Index	Speed Symbol	Comments	
12.00R24	160 /156	K		C B 71 )) <b>(M+S)</b>
325/95R24	162 /160	K		C B 71 )) <b>(M+S)</b>

# Omnitrac MSS

The Goodyear Omnitrac MSS 445/75R22.5 and 375/90R22.5 are especially designed for high load vehicles in mixed service and on-road applications.



- Specific tear- and wear-resistance
- Added protection against cuts, chipping and chunking
- Excellent traction, handling
- Increased cargo payload and flotation characteristics

## Technical Data



Size	Load Index	Speed Symbol	Comments	
11R22.5	148/145	K		D B 70 )) <b>(M+S)</b>
375/90R22.5	164	G		C B 70 )) <b>(M+S)</b>

Size	Load Index	Speed Symbol	Comments	
445/75R22.5	170	J		C B 71 )) <b>(M+S)</b>



# Omnitrac MSD II



The Omnitrac MSD II with a specifically developed robust tread pattern provides excellent traction in on and off road conditions, high mileage in on road use and good damage resistance. The specific groove layouts ensure good self cleaning and reduced stone holding.



- Excellent traction and braking
- High mileage, even wear pattern
- Excellent self cleaning
- Enhanced traction on unpaved surfaces and on mud
- Excellent durability and retreadability

## Technical Data



Size	Load Index	Speed Symbol	Comments	
12.00R20	154/150	K		E B 73 ))
13R22.5	156/150	K		E B 72 ))
315/80R22.5	156/150	K		D C 74 ))
295/80R22.5	152/148	K		E B 74 ))

Size	Load Index	Speed Symbol	Comments	
12.00R24	160/156	K	MSD II Plus	C B 71 )
325/95R24	162/160	K	MSD II Plus	D B 72 )

# Omnitrac MSD II Super Single



1st in industry – “Super Single” drive axle tyres for mixed service/ construction site applications. The super single range is the best alternative to “dual mounted” drive axle tyre fitments on mixed service trucks. The tread pattern is specifically developed to provide excellent traction and braking on mud and wet surfaces, combined to good damage resistance.



- Light weight super single mixed-service drive tyre
- Wide tread providing an excellent mileage
- Slalom centerline groove for improved on/off-road braking and traction
- Good stone drilling resistance and groove self cleaning
- Excellent durability and retreadability

## Technical Data



Size	Load Index	Speed Symbol	Comments	
385/55R22.5	160	K		C C 73 ))

Size	Load Index	Speed Symbol	Comments	
495/45R22.5	169	K		C D 74 ))

# Omnitrac T



FRT

Goodyear OMNITRAC T features a wide tread and multi radii cavity for even wear and high mileage potential. A Zig-Zag centerline groove and off-set block edge design offer an improved on/ off road traction and massive centerline ribs increase the damage resistance.



- High mileage potential, increased resistance to cuts, chipping and chunking
- Excellent wet grip, 3PMSF marking
- Self-cleaning
- Excellent traction and resistance to chunking
- Increased durability and retreadability

## Technical Data



Size	Load Index	Speed Symbol	Comments		Size	Load Index	Speed Symbol	Comments	
385/65R22.5	160 (158)	K (L)		C B 72 ))	445/65R22.5	169	K	MST II design	B B 71 ))





## LEGEND



**M+S (Mud and Snow)** indicates that a tyre has better snow traction than a regular tyre (see details on page 82)



**3PMSF (Three Peak Mountain Snowflake)** indicates that a tyre has passed a minimum performance threshold requirement on snow (see details on page 82)



**TreadMax** retreads are produced exclusively in-house and utilise the same casing, tread pattern and materials as new tyres – resulting in a similar to new tyre performance (see details on page 60)



**FRT (Free Rolling Tyre)** indicates that the tyre should only be fitted to free rolling axles, such as trailer applications (see details on page 82)

**POR**

“Professional Off-Road” tyres for commercial use. POR tyres are specially designed for poor road conditions and do not have EU labels as they do not meet the tyre EU labelling directives.



# Offroad Tyre Range.



# Offroad ORS 22.5"

The Offroad ORS steer tyre provides excellent mileage while featuring damage resistant tread patterns.



M+S

- Road handling and lateral stability
- Excellent mileage
- Even wear profile
- High damage, traction and wet skid resistance
- Maximized stone penetration protection

## Technical Data



Size	Load Index	Speed Symbol	Comments	
315/80R22.5	156/150	K		D B 70 ) M+S

# Offroad ORD 14.00R20, 365/85R20 and 375/90R22.5

Originally developed for special military, airport fire brigade and road maintenance applications, the Goodyear Offroad ORD gives excellent off-road traction, stone holding resistance and balanced wear around the circumference.

- Optimum durability and retreadability
- Exceptional off-road traction and cutting resistance
- Resistance to tearing and cutting for more kilometres
- Self-cleaning to avoid stone holding and increase traction



M+S



M+S

## Technical Data



Size	Load Index	Speed Symbol	Comments	
14.00R20	164 /160 (166/160)	J (G)		POR M+S



Size	Load Index	Speed Symbol	Comments	
365/85R20	164	J		D B 75 ) M+S
375/90R22.5	164	G		POR M+S

# Offroad ORD 22.5" and 24"

The Goodyear Offroad ORD is a specific tyre for off-road applications. It provides excellent damage resistance and enhanced traction properties even on soft or sandy surfaces.



- Secure off-road traction and high mileage
- Exceptional resistance to tearing and cutting
- Excellent resistance to stone holding and self-cleaning ability

## Technical Data



Size	Load Index	Speed Symbol	Comments	
12R22.5	152 /148	J		POR
13R22.5	156 /150 (154/150)	G (J)		POR

Size	Load Index	Speed Symbol	Comments	
12.00R24	160 /156	G		POR
325/95R24	162 /160	G		POR



#### LEGEND



**M+S (Mud and Snow)** indicates that a tyre has better snow traction than a regular tyre (see details on page 82)



**3PMSF (Three Peak Mountain Snowflake)** indicates that a tyre has passed a minimum performance threshold requirement on snow (see details on page 82)



**TreadMax retreads** are produced exclusively in-house and utilise the same casing, tread pattern and materials as new tyres – resulting in a similar to new tyre performance (see details on page 60)





# Urban Tyre Range.



**GOODYEAR**

# UrbanMax MCA



The MCA municipal tyre, featuring UrbanMax Technology, a combination of latest technology tread pattern and state of the art materials. UrbanMax MCA tyres are specifically developed to provide excellent mileage in “stop & go” applications. In addition it provides good braking and traction on wet. MCA tyres are usable as steer or as all position tyres on municipal vehicles. All season use possible (3PMSF marked).



- Wide tread, 5 robust ribs, for superb mileage and even wear
- Centerline blocks with edge and flexomatic blading for good braking on wet and all season capability.
- Reinforced sidewalls, with wear indicators, to resist to curb scuffing and enhanced durability and damage resistance
- Regroovable and retreadable

## Technical Data



Size	Load Index	Speed Symbol	Comments	
265/70R19.5	140 /138	L		D C 70 )
11R22.5	148 /145 (152 /148)	J (E)		D C 72 ))
295/80R22.5	152 /148 (154 /150)	J (E)		D C 71 )

Size	Load Index	Speed Symbol	Comments	
275/70R22.5	148 /145 (152 /148)	J (E)		E C 71 )
275/70R22.5	150 /145 (152 /148)	J (E)	High Load version	D C 71 )
315/60R22.5	152 /148	J		C C 72 ))

# UrbanMax MCS



The UrbanMax MCS\* is a municipal tyre featuring UrbanMax technology that provides high performance on road and excellent damage resistance.



- Reinforced sidewalls
- Maximized stone penetration protection
- High tearing and cutting resistance
- Even wear tread design

## Technical Data



Size	Load Index	Speed Symbol	Comments	
305/70R22.5	152/148 (154/150)	J (E)		D C 71 ))

# UrbanMax MCD\* Traction



The MCD\* Traction is a municipal tyre featuring UrbanMax technology specifically developed to provide excellent mileage in normal and winter applications. Also providing superb mileage and good braking.



- Flexomatic blading and 3D-BIS providing mileage, handling and rolling resistance
- Blade density providing winter and wet performance
- Non-intrusive shoulder decreasing damage
- Optimised footprint and pressure distribution for even wear and enhanced tread damage resistance
- Reinforced sidewall providing trouble free lifelong protection

## Technical Data



Size	Load Index	Speed Symbol	Comments			
275/70R22.5	148/145 (152/148)	J (E)		E C 72 )		

# UrbanMax MCD Super Single



Specifically designed super single tyre for urban bus applications. The 455/45R22.5 is an alternative to dual mounted 275/70R22.5 tyres, providing more inside space, reduced weight and lower rolling resistance.



- Reduced weight
- Lower Rolling Resistance
- Increased inside space

## Technical Data



Size	Load Index	Speed Symbol	Comments			
455/45R22.5	166	J		C C 73 )		

## LEGEND

---



**M+S (Mud and Snow)** indicates that a tyre has better snow traction than a regular tyre (see details on page 82)

---



**3PMSF (Three Peak Mountain Snowflake)** indicates that a tyre has passed a minimum performance threshold requirement on snow (see details on page 82)

---



**TreadMax retreads** are produced exclusively in-house and utilise the same casing, tread pattern and materials as new tyres – resulting in a similar to new tyre performance (see details on page 60)



# Coach Tyre Range.



**GOODYEAR**

# Marathon Coach



Asymmetric pattern dedicated for all position fitment on long haul and intercity coach applications. Providing excellent mileage, resistance to shoulder wear and high comfort level.



- Excellent mileage potential and even wear
- Excellent Ride/Handling and Comfort
- High resistance to irregular wear and tread cracks
- Low noise level
- Reduced rolling resistance
- Excellent wet skid performance
- Long lasting carcass & tyre life

## Technical Data



Size	Load Index	Speed Symbol	Comments		Size	Load Index	Speed Symbol	Comments	
295/80R22.5	154/149	M	High Load version	C B 71 )	315/80R22.5	156/150 (154/150)	L (M)	B B 70 )	

# ULTRA GRIP Coach



Specific high blade density winter traction drive tyre for long haul and intercity coaches. Decoupled blocks and high tear resistance compound lead to a combination of mileage performance and snow traction.



- High grip/traction on snowy/icy road
- Extended mileage
- Even wear profile
- Road handling & lateral stability
- Stone damage & cut resistances
- Robust shoulder rib

## Technical Data



Size	Load Index	Speed Symbol	Comments		Size	Load Index	Speed Symbol	Comments	
295/80R22.5	154/149	M	High Load version	D C 72 )	315/80R22.5	156/150 (154/150)	L (M)		D C 73 )



#### LEGEND



**M+S (Mud and Snow)** indicates that a tyre has better snow traction than a regular tyre (see details on page 82)



**3PMSF (Three Peak Mountain Snowflake)** indicates that a tyre has passed a minimum performance threshold requirement on snow (see details on page 82)



**TreadMax** retreads are produced exclusively in-house and utilise the same casing, tread pattern and materials as new tyres – resulting in a similar to new tyre performance (see details on page 60)



**FRT (Free Rolling Tyre)** indicates that the tyre should only be fitted to free rolling axles, such as trailer applications (see details on page 82)





# Winter Tyre Range.



**GOODYEAR**

# ULTRA GRIP MAX S



The new ULTRA GRIP MAX S steer tyre provides excellent cornering stability and optimum braking performance on snow and ice, to allow you to face the toughest winter conditions.

Thanks to ULTRA GRIP MAX Technology the ULTRA GRIP MAX S is the ideal choice for fleets looking for winter performance throughout the life of the tyre.



- Improved snow grip throughout tyre life
- 30% more snow grip compared to its predecessor when tyres are half worn\*
- Optimum lateral grip for good cornering stability, especially on snow and ice
- Excellent braking performance on slippery surfaces like snow & ice
- High mileage potential and good carcass resistance

\* Comparative tests made by Goodyear GIC\*L on size 315/80R22.5 show that the new Goodyear ULTRA GRIP MAX S offers an improvement in snow grip of up to 30% compared to Goodyear ULTRA GRIP WTS. Actual results may vary based on, but not restricted to, road and weather conditions, tyre size, tyre pressure and vehicle maintenance.

## Technical Data



Size	Load Index	Speed Symbol	Comments	Grip & Mileage			
295/80R22.5	154/149	L	High Load version	D	B	72 )	(M+S) (TreadMax)
315/80R22.5	156/150 (154/150)	L (M)		C	B	72 )	(M+S) (TreadMax)
315/70R22.5	156/150	L	High Load version	C	B	73 )	(M+S) (TreadMax)
385/65R22.5	160 (158)	K (L)		C	B	73 )	(M+S) (TreadMax)

Size	Load Index	Speed Symbol	Comments	Grip & Mileage			
295/60R22.5	150/147 (149/146)	K (L)		C	B	72 )	(M+S) (TreadMax)
315/60R22.5	154/148	L	High Load version	C	C	72 )	(M+S) (TreadMax)
385/55R22.5	160 (158)	K (L)		C	B	74 )	(M+S) (TreadMax)

# ULTRA GRIP MAX D



The new ULTRA GRIP MAX D drive tyre provides traction on snow and ice throughout the tyre life allowing you to still have winter traction capability at Three Peak Mountain Snowflake standard level when the tyre is 50% worn.

Thanks to Goodyear ULTRA GRIP MAX Technology ULTRA GRIP MAX D is the ideal choice for fleets looking for mobility in extreme winter conditions.



- Improved snow grip and mileage
- 40% more snow grip compared to its predecessor when tyres are half worn\*
- 15% more mileage compared to its predecessor\*
- Even tyre wear with high mileage potential and low noise emission
- Outstanding traction on slippery surfaces like snow and ice throughout the tyre life
- Excellent tread durability and carcass resistance, improving retreadability compared to its predecessor

\* Comparative tests made by Goodyear GIC\*L on size 315/80R22.5 show that:  
 – the Goodyear ULTRA GRIP MAX D offers an improvement in snow grip of up to 40% compared to Goodyear ULTRA GRIP WTD;  
 – the Goodyear ULTRA GRIP MAX D drive tyres offer an improvement in mileage potential of up to 15% compared to Goodyear ULTRA GRIP WTD.  
 Actual results may vary based on, but not restricted to, road and weather conditions, tyre size, tyre pressure and vehicle maintenance.

## Technical Data



Size	Load Index	Speed Symbol	Comments	Grip & Mileage			
295/80R22.5	152/148	M		E	C	73 )	(M+S) (TreadMax)
315/80R22.5	156/150 (154/150)	L (M)		E	B	74 )	(M+S) (TreadMax)

Size	Load Index	Speed Symbol	Comments	Grip & Mileage			
315/70R22.5	154/150 (152/148)	L (M)		E	C	74 )	(M+S) (TreadMax)
295/60R22.5	150/147 (149/146)	K (L)		D	C	73 )	(M+S) (TreadMax)
315/60R22.5	152/148	L		D	C	74 )	(M+S) (TreadMax)

# ULTRA GRIP MAX T



The new ULTRAGRIP MAX T trailer tyre provides excellent lateral stability and snow grip, to allow you to face the toughest winter conditions.

The ULTRA GRIP MAX T is the ideal choice for fleets looking for a winter solution for their trailers.



- Resistance against carcass damage and increased mileage potential
- Good grip on slippery surfaces for excellent braking performances on winter roads
- Good lateral stability and even wear

## Technical Data



Size	Load Index	Speed Symbol	Comments				
385/65R22.5	164 (158)	K (L)	High Load version	C	B	73 ))	
385/65R22.5	160 (158)	K (L)		C	B	74 ))	

Size	Load Index	Speed Symbol	Comments				
385/55R22.5	160/158	K (L)		C	B	73 ))	

# UltraGrip WTS



The UltraGrip WTS steer axle tyre provides a wide, deep tread pattern, specific “Z” blades and a specific technology tread compound, resulting in excellent mileage and traction and braking on wet, snow and ice roads.

WTS City design includes as well reinforced sidewall for better damage resistance in urban applications.



- Excellent braking and traction on wet and snow
- Superb lateral grip, handling and steering stability
- High mileage, even wear pattern
- Usable as “all position” fitment

## Technical Data



Size	Load Index	Speed Symbol	Comments	
275/70R22.5	148 /145 (152/148)	J (E)	City version	E C 73 ))

Size	Load Index	Speed Symbol	Comments	
355/50R22.5	154 (152)	K (L)		D B 73 ))

# UltraGrip WTD



The UltraGrip WTD drive axle tyre is designed to provide outstanding traction on snowy, icy roads while featuring dedicated technology tread compounds and carcass constructions. The WTD tyre is dedicated for use in severe winter conditions. With a specific blading technology, traction, stability and braking are improved while still providing high mileage performance.

WTD City design includes as well reinforced sidewalls for better damage resistance in urban applications.



- Excellent winter traction and braking (snow and ice)
- Superb lateral grip, handling and steering stability
- High mileage, even wear pattern

## Technical Data



Size	Load Index	Speed Symbol	Comments	
275/70R22.5	148/145 (152/148)	J (E)	City version	E D 73 ))

# UltraGrip WTT 19.5"



Goodyear UltraGrip WTT truck tyre has been developed to cope with today's demanding winter transport operations. The trailer axle tyre features excellent performance in winter conditions, keeping fleet efficiency at maximum level by providing good mileage and all season capability. The 265/70R19.5 UltraGrip WTT winter trailer tyre complements the steer and drive tyre range, for specific severe winter conditions. The WTT was developed for the use on paved roads as well as on unpaved and forest roads. The high level of carcass robustness against external damages meets the needs of latter application.



- 4-rib design for massive rib distribution and excellent damage resistance
- Wide tread width for an extended mileage and a good lateral stability
- Excellent snow / mud traction thanks to staggered blocks and semi-open shoulders

## Technical Data



Size	Load Index	Speed Symbol	Comments	
265/70R19.5	143/141	J		D B 72 ))





# Technical Data.

Technical Data

**GOODYEAR**

# Technical Data

Size	Goodyear Design	Load Index	Tyre Dimensions <sup>(1)</sup>				Nominal Pressure [bar]	Max Load		Rim Data		
			Overall Diameter [mm] (+/- 1.5%)	Overall Section Width [mm] (+/- 1.5%)	Static Loaded Radius [mm]	Rolling Circumf. [mm]		Single Axle Load [kg]	Dual Axle Load [kg]	Recomm. Rim Width	Permitted Rim Width	Min. Dual Spacing
<b>15" Low Platform Trailer Tyres</b>												
7.50 R 15	ETRTO	135/133	772	212	357	2355	8,50	4360	8240	6.00	6.00-6.50	242
	Regional RHT	135/133	784	209	361	2393	8,50	4360	8240	6.00	6.00-6.50	242
8.25 R 15	ETRTO	143/141	836	234	384	2550	8,75	5450	10300	6.50	5.50-7.00	265
	Regional RHT	143/141	845	234	385	2579	8,75	5450	10300	6.50	6.00-7.00	265
<b>17.5" Sizes – Standard Series</b>												
8.5 R 17.5	ETRTO	121/120	802	215	374	2446	6,25	2900	5600	6.00	5.25/6.75	242
	Regional RHS	121/120	805	207	374	2457	6,25	2900	5600	5.25	5.25/6.75	233
	Regional RHD	121/120	808	207	376	2466	6,25	2900	5600	5.25	5.25/6.75	233
9.5 R 17.5	ETRTO	129/127	842	240	391	2568	7,50	3700	7000	6.75	6.00-6.75	270
	Regional RHS II	129/127	847	241	392	2585	7,50	3700	7000	6.00	6.00-6.75	261
	Regional RHD II	129/127	855	237	400	2610	7,50	3700	7000	6.00	6.00-6.75	261
	Regional RHT II	143/141	846	246	390	2582	8,75	5450	10300	6.75	6.00-6.75	270
10 R 17.5	ETRTO	134/132	858	254	398	2617	8,00	4240	8000	7.50	6.75-7.50	286
	Unisteel G291	134/132	858	246	398	2615	8,00	4240	8000	6.75	6.75-7.50	277
	Unisteel G124	134/132	862	239	405	2630	8,00	4240	8000	6.75	6.75-7.50	277
<b>17.5" Sizes – 75 Series</b>												
205/75 R 17.5	ETRTO	124/122	753	204	353	2297	7,50	3200	6000	6.00	5.25-6.75	231
	KMAX S	124/122	758	210	355	2310	7,50	3200	6000	6.00	5.25-6.75	231
	KMAX D	124/122	760	209	356	2305	7,50	3200	6000	6.00	5.25-6.75	231
215/75 R 17.5	ETRTO	126/124	767	211	359	2339	7,00	3400	6400	6.00	6.00-6.75	239
	KMAX S HL	128/126	774	217	361	2352	7,50	3600	6800	6.00	6.00-6.75	239
	KMAX D	126/124	776	217	362	2349	7,00	3400	6400	6.00	6.00-6.75	239
	KMAX T	135/133	769	215	355	2350	8,50	4360	8240	6.00	6.00-6.75	239
225/75 R 17.5	ETRTO	129/127	783	226	366	2388	7,25	3700	7000	6.75	6.00 -6.75	254
	KMAX S	129/127	787	232	367	2393	7,25	3700	7000	6.75	6.00 -6.75	254
	KMAX D	129/127	790	232	368	2390	7,25	3700	7000	6.75	6.00 -6.75	254
235/75 R 17.5	ETRTO	132/130	797	233	372	2431	7,75	4000	7600	6.75	6.75-7.50	262
	KMAX S	132/130	806	236	376	2448	7,75	4000	7600	6.75	6.75-7.50	262
	KMAX D	132/130	807	236	377	2449	7,75	4000	7600	6.75	6.75-7.50	262
	KMAX T	143/141	801	237	368	2450	8,75	5450	10300	6.75	6.75-7.50	262
<b>17.5" Sizes – 70 Series</b>												
245/70 R 17.5	ETRTO	136/134	789	248	364	2406	8,50	4480	8480	7.50	6.75-7.50	279
	KMAX S	136/134	794	246	368	2430	8,50	4480	8480	7.50	6.75-7.50	279
	KMAX D	136/134	795	245	369	2422	8,50	4480	8480	7.50	6.75-7.50	279
	KMAX T	143/141	793	256	365	2428	8,75	5450	10300	7.50	6.75-7.50	279
265/70 R 17.5	ETRTO	139/136	817	262	376	2492	8,00	4860	8960	7.50	6.75/7.50	295
	KMAX S	139/136	816	256	378	2488	8,00	4860	8960	7.50	6.75/7.50	295
	KMAX D	139/136	818	256	379	2481	8,00	4860	8960	7.50	6.75/7.50	295
<b>17.5" Sizes – 65 Series</b>												
205/65 R 17.5	ETRTO	129/127	711	204	329	2154	9,00	3700	7000	6.00	6.00-6.75	231
	KMAX T	129/127	716	213	334	2199	9,00	3700	7000	6.00	6.00-6.75	231
<b>19.5" Sizes – 70 Series</b>												
245/70 R 19.5	ETRTO	136/134	839	248	389	2559	8,25	4480	8480	7.50	6.75-7.50	279
	KMAX S	136/134	836	242	389	2555	8,25	4480	8480	6.75	6.75-7.50	270
	KMAX D	136/134	837	241	390	2555	8,25	4480	8480	6.75	6.75-7.50	270
	KMAX T	141/140	848	252	389	2589	8,50	5150	10000	7.50	6.75-7.50	279
265/70 R 19.5	ETRTO	140/138	867	262	401	2644	7,75	5000	9440	7.50	6.75-8.25	295
	KMAX S	140/138	866	263	402	2650	7,75	5000	9440	7.50	6.75-8.25	295
	KMAX D	140/138	868	263	402	2646	7,75	5000	9440	7.50	6.75-8.25	295
	UrbanMax MCA	140/138	873	271	406	2665	7,75	5000	9440	7.50	6.75-8.25	295
	Omnitrac MSS II	143/141	872	269	405	2662	8,50	5450	10300	7.50	7.50-8.25	295
	KMAX T	143/141	866	266	400	2643	8,50	5450	10300	7.50	7.50-8.25	295
	UltraGrip WTT	143/141	876	266	405	2674	8,50	5450	10300	7.50	7.50-8.25	295
285/70 R 19.5	ETRTO	146/144	895	283	413	2730	9,00	6000	11200	8.25	7.50-9.00	318

<sup>(1)</sup> Measured tyre dimension using the Goodyear recommended rim

<sup>(2)</sup> For any tyre design not listed or in preparation please use the ETRTO data instead



**Load Capacity per Axle [kg] at Inflation Pressure [bar]**

Load Index	Single / Dual Fitment	Tyre pressure in bar														
		5,00	5,50	6,00	6,25	6,50	6,75	7,00	7,25	7,50	7,75	8,00	8,25	8,50	8,75	9,00
<b>135</b>	<b>S</b>	2860	3080	3300	3410	3520	3630	3740	3840	3950	3950	4160	4260	<b>4360</b>		
<b>133</b>	<b>D</b>	5390	5820	6240	6450	6650	6860	7060	7260	7460	7660	7850	8050	<b>8240</b>		
<b>143</b>	<b>S</b>	3480	3760	4030	4160	4300	4430	4560	4690	4810	4950	5070	5200	5330	<b>5450</b>	
<b>141</b>	<b>D</b>	6580	7100	7620	7870	8120	8370	8620	8860	9100	9350	9590	9830	10060	<b>10300</b>	
<b>121</b>	<b>S</b>	2430	2620	2810	<b>2900</b>											
<b>120</b>	<b>D</b>	4690	5060	5420	<b>5600</b>											
<b>129</b>	<b>S</b>	2680	2890	3100	3200	3300	3410	3500	3600	<b>3700</b>						
<b>127</b>	<b>D</b>	5060	5460	5860	6050	6240	6440	6620	6810	<b>7000</b>						
<b>143</b>	<b>S</b>	3480	3760	4030	4170	4300	4430	4560	4690	4820	4950	5070	5200	5330	<b>5450</b>	
<b>141</b>	<b>D</b>	6580	7100	7620	7870	8120	8370	8620	8860	9110	9350	9590	9830	10060	<b>10300</b>	
<b>134</b>	<b>S</b>	2920	3150	3370	3490	3600	3710	3820	3920	4030	4140	<b>4240</b>				
<b>132</b>	<b>D</b>	5500	5930	6360	6570	6780	6990	7190	7400	7600	7800	<b>8000</b>				
<b>124</b>	<b>S</b>	2310	2500	2680	2770	2850	2950	3030	3110	<b>3200</b>						
<b>122</b>	<b>D</b>	4340	4680	5020	5190	5350	5520	5680	5840	<b>6000</b>						
<b>126</b>	<b>S</b>	2600	2800	3000	3110	3200	3300	<b>3400</b>								
<b>124</b>	<b>D</b>	4890	5280	5650	5850	6030	6220	<b>6400</b>								
<b>128</b>	<b>S</b>	2600	2810	3010	3110	3210	3310	3410	3500	<b>3600</b>						
<b>126</b>	<b>D</b>	4920	5310	5690	5880	6060	6250	6430	6620	<b>6800</b>						
<b>135</b>	<b>S</b>	2850	3080	3300	3410	3520	3630	3730	3840	3940	4050	4150	4260	<b>4360</b>		
<b>133</b>	<b>D</b>	5390	5820	6240	6450	6650	6860	7050	7260	7450	7650	7850	8050	<b>8240</b>		
<b>129</b>	<b>S</b>	2750	2970	3180	3290	3390	3500	3600	<b>3700</b>							
<b>127</b>	<b>D</b>	5200	5610	6020	6220	6410	6620	6810	<b>7000</b>							
<b>132</b>	<b>S</b>	2820	3040	3260	3370	3470	3590	3690	3790	3900	<b>4000</b>					
<b>130</b>	<b>D</b>	5350	5780	6190	6400	6600	6810	7010	7210	7400	<b>7600</b>					
<b>143</b>	<b>S</b>	3480	3760	4030	4170	4300	4430	4560	4690	4820	4950	5070	5200	5330	<b>5450</b>	
<b>141</b>	<b>D</b>	6580	7110	7620	7870	8120	8370	8620	8870	9100	9350	9590	9830	10060	<b>10300</b>	
<b>136</b>	<b>S</b>	2930	3160	3390	3510	3610	3730	3840	3940	4050	4160	4270	4370	<b>4480</b>		
<b>134</b>	<b>D</b>	5550	5990	6420	6640	6840	7060	7260	7470	7670	7880	8080	8280	<b>8480</b>		
<b>143</b>	<b>S</b>	3480	3760	4030	4170	4300	4430	4560	4690	4820	4950	5070	5200	5330	<b>5450</b>	
<b>141</b>	<b>D</b>	6580	7110	7620	7870	8130	8370	8620	8860	9100	9350	9590	9830	10060	<b>10300</b>	
<b>139</b>	<b>S</b>	3340	3600	3860	3990	4120	4250	4370	4490	4620	4740	<b>4860</b>				
<b>136</b>	<b>D</b>	6150	6640	7120	7360	7590	7830	8050	8280	8510	8740	<b>8960</b>				
<b>129</b>	<b>S</b>	2310	2500	2680	2770	2850	2940	3030	3110	3200	3280	3370	3450	3530	3620	<b>3700</b>
<b>127</b>	<b>D</b>	4370	4720	5060	5230	5400	5570	5730	5890	6050	6210	6370	6530	6690	6840	<b>7000</b>
<b>136</b>	<b>S</b>	3000	3240	3470	3590	3700	3820	3930	4040	4150	4260	4370	<b>4480</b>			
<b>134</b>	<b>D</b>	5680	6130	6570	6800	7010	7230	7440	7650	7860	8070	8270	<b>8480</b>			
<b>141</b>	<b>S</b>	3370	3640	3900	4030	4160	4290	4410	4530	4660	4780	4910	5030	<b>5150</b>		
<b>140</b>	<b>D</b>	6540	7060	7570	7820	8070	8320	8560	8810	9050	9290	9530	9760	<b>10000</b>		
<b>140</b>	<b>S</b>	3520	3800	4070	4210	4340	4480	4610	4740	4870	<b>5000</b>					
<b>138</b>	<b>D</b>	6650	7170	7690	7950	8200	8460	8700	8950	9200	<b>9440</b>					
<b>143</b>	<b>S</b>	3560	3850	4120	4270	4400	4540	4670	4800	4930	5060	5190	5320	<b>5450</b>		
<b>141</b>	<b>D</b>	6740	7270	7800	8060	8310	8570	8820	9070	9320	9570	9810	10060	<b>10300</b>		
<b>146</b>	<b>S</b>	3750	4050	4340	4490	4620	4770	4910	5050	5190	5320	5460	5600	5730	5870	<b>6000</b>

# Technical Data

			Tyre Dimensions <sup>(1)</sup>				Max Load			Rim Data		
Size	Goodyear Design	Load Index	Overall Diameter [mm] (+/- 1.5%)	Overall Section Width [mm] (+/- 1.5%)	Static Loaded Radius [mm]	Rolling Circumf. [mm]	Nominal Pressure [bar]	Single Axle Load [kg]	Dual Axle Load [kg]	Recomm. Rim Width	Permitted Rim Width	Min. Dual Spacing
	KMAX S	146/144	888	277	399	2720	9,00	6000	11200	8.25	7.50-9.00	318
	KMAX D	146/144	895	279	417	2729	9,00	6000	11200	8.25	7.50-9.00	318
	KMAX T	150/148	892	289	410	2723	9,00	6700	12600	8.25	8.25-9.00	318
305/70 R 19.5	ETRTO	148/145	923	305	424	2815	8,50	6300	11600	9.00	8.25-9.00	343
	KMAX S	148/145	921	297	425	2812	8,50	6300	11600	9.00	8.25-9.00	343
	KMAX D	148/145	926	295	433	2823	8,50	6300	11600	9.00	8.25-9.00	343
<b>19.5" Sizes – 55 Series</b>												
265/55 R 19.5	ETRTO	141/140	787	264	368	2400	9,00	5150	10000	8.25	8.25	297
	KMAX T	141/140		in preparation <sup>(2)</sup>			9,00	5150	10000	8.25	8.25	297
	Marathon LHT	141/140	783	269	364	2390	9,00	5150	10000	8.25	8.25	297
<b>19.5" Sizes – 50 Series</b>												
435/50 R 19.5	ETRTO	160	931	438	422	2840	9,00	9000		14.00	14.00-15.00	
	FUELMAX T	160	920	429	421	2788	9,00	9000		14.00	14.00-15.00	
	FUELMAX T HL	164	920	431	418	2825	9,00	10000		14.00	14.00-15.00	
	KMAX T GEN-2	160		in preparation <sup>(2)</sup>			9,00	9000		14.00	14.00-15.00	
	KMAX T	160	925	427	423	2803	9,00	9000		14.00	14.00-15.00	
<b>20" Sizes – Standard Series</b>												
12.00 R 20	ETRTO	154/150	1122	313	513	3422	8,50	7500	13400	8.50	7.50-9.00	360
	Omnitrac MSS II	154/150	1126	313	526	3437	8,50	7500	13400	8.50	7.50-9.00	360
	Omnitrac MSD II	154/150	1133	313	530	3458	8,50	7500	13400	8.50	7.50-9.00	360
14.00 R 20	ETRTO	164/160	1238	370	564	3776	7,50	10000	18000	10.00	9.00/10.00/10.00	426
	Offroad ORD	164/160	1258	377	573	3840	7,50	10000	18000	10.00	9.00-10.00	426
<b>20" Sizes – 85 Series</b>												
365/85 R 20	ETRTO	164	1128	364	518	3440	8.00	10000		10.00	10.00	
	Offroad ORD	164	1124	358	511	3465	8.00	10000		10.00	10.00	
<b>22.5" Sizes – Standard Series</b>												
10 R 22.5	ETRTO	144/142	1020	254	476	3111	8,50	5600	10600	7.50	6.75-7.50	286
	Unisteel G391	144/142	1020	246	476	3110	8,50	5600	10600	6.75	6.75-7.50	277
11 R 22.5	ETRTO	148/145	1050	279	489	3203	8,50	6300	11600	8.25	7.50-8.25	305
	Regional RHS II	148/145	1058	274	492	3230	8,50	6300	11600	7.50	7.50-8.25	305
	Regional RHD II	148/145	1064	275	497	3248	8,50	6300	11600	7.50	7.50-8.25	305
	UrbanMax MCA	148/145	1065	284	499	3251	8,50	6300	11600	7.50	7.50-8.25	305
	Omnitrac MSS	148/145	1059	274	492	3233	8,50	6300	11600	7.50	7.50-8.25	305
	Marathon LHT	148/145	1054	275	492	3217	8,50	6300	11600	7.50	7.50-8.25	305
12 R 22.5	ETRTO	152/148	1084	300	504	3306	8,50	7100	12600	9.00	8.25-9.00	338
	Regional RHS II	152/148	1083	296	502	3306	8,50	7100	12600	8.25	8.25-9.00	329
	Regional RHD II	152/148	1091	299	509	3330	8,50	7100	12600	8.25	8.25-9.00	329
	Omnitrac MSS II	152/148	1091	298	508	3330	8,50	7100	12600	8.25	8.25-9.00	329
	Omnitrac MSD II	152/148	1100	298	513	3358	8,50	7100	12600	8.25	8.25-9.00	329
	OMNITRAC S HEAVY DUTY	152/148		in preparation <sup>(2)</sup>			8,50	7100	12600	8.25	8.25-9.00	329
	OMNITRAC D HEAVY DUTY	152/148		in preparation <sup>(2)</sup>			8,50	7100	12600	8.25	8.25-9.00	329
Offroad ORD	152/148	1102	296	512	3364	8,50	7100	12600	8.25	8.25-9.00	329	
13 R 22.5	ETRTO	156/150	1124	320	521	3428	8,75	8000	13400	9.75	9.00-9.75	360
	Regional RHS II	156/150	1120	318	519	3419	8,75	8000	13400	9.00	9.00-9.75	351
	Regional RHD II	156/150	1134	316	526	3462	8,75	8000	13400	9.00	9.00-9.75	351
	OMNITRAC S	156/150	1126	315	527	3447	8,75	8000	13400	9.00	9.00-9.75	351
	OMNITRAC D	156/150	1132	315	530	3447	8,75	8000	13400	9.00	9.00-9.75	351
	OMNITRAC S HEAVY DUTY	156/150		in preparation <sup>(2)</sup>			8,75	8000	13400	9.00	9.00-9.75	351
	OMNITRAC D HEAVY DUTY	156/150		in preparation <sup>(2)</sup>			8,75	8000	13400	9.00	9.00-9.75	351
	Offroad ORD	156/150	1140	319	533	3480	8,75	8000	13400	9.00	9.00-9.75	351
	<b>22.5" Sizes – 90 Series</b>											

<sup>(1)</sup> Measured tyre dimension using the Goodyear recommended rim

<sup>(2)</sup> For any tyre design not listed or in preparation please use the ETRTO data instead

**Load Capacity per Axle [kg] at Inflation Pressure [bar]**

Load Index	Single / Dual Fitment	Tyre pressure in bar														
		5,00	5,50	6,00	6,25	6,50	6,75	7,00	7,25	7,50	7,75	8,00	8,25	8,50	8,75	9,00
<b>144</b>	<b>D</b>	7000	7550	8100	8370	8630	8900	9160	9420	9680	9940	10190	10450	10700	10950	<b>11200</b>
<b>150</b>	<b>S</b>	4190	4520	4840	5010	5160	5330	5480	5640	5790	5940	6100	6250	6400	6560	<b>6700</b>
<b>148</b>	<b>D</b>	7870	8500	9110	9420	9710	10010	10310	10600	10890	11180	11470	11750	12040	12320	<b>12600</b>
<b>148</b>	<b>S</b>	4120	4450	4770	4930	5080	5240	5390	5550	5700	5850	6000	6150	<b>6300</b>		
<b>145</b>	<b>D</b>	7590	8190	8780	9080	9360	9650	9930	10210	10490	10770	11050	11330	<b>11600</b>		
<b>141</b>	<b>S</b>	3220	3470	3720	3850	3970	4100	4210	4330	4450	4570	4690	4800	4920	5040	<b>5150</b>
<b>140</b>	<b>D</b>	6250	6740	7230	7470	7710	7950	8180	8410	8640	8870	9100	9330	9550	9780	<b>10000</b>
<b>160</b>	<b>S</b>	5620	6070	6510	6730	6940	7150	7360	7570	7780	7990	8190	8390	8600	8800	<b>9000</b>
<b>164</b>	<b>S</b>	6250	6740	7230	7470	7710	7940	8180	8410	8640	8870	9100	9330	9550	9780	<b>10000</b>
<b>154</b>	<b>S</b>	4910	5290	5680	5870	6050	6240	6420	6600	6790	6970	7140	7320	<b>7500</b>		
<b>150</b>	<b>D</b>	8760	9460	10140	10480	10810	11150	11470	11800	12120	12450	12770	13080	<b>13400</b>		
<b>164</b>	<b>S</b>	7230	7800	8370	8650	8920	9200	9460	9730	<b>10000</b>						
<b>160</b>	<b>D</b>	13010	14040	15060	15560	16050	16550	17030	17520	<b>18000</b>						
<b>164</b>	<b>S</b>	6870	7410	7940	8210	8470	8730	8990	9240	9500	9750	<b>10000</b>				
<b>144</b>	<b>S</b>	3670	3960	4240	4380	4520	4660	4800	4940	5070	5120	5340	5470	<b>5600</b>		
<b>142</b>	<b>D</b>	6940	7490	8030	8290	8560	8820	9080	9340	9600	9850	10100	10350	<b>10600</b>		
<b>148</b>	<b>S</b>	4120	4450	4770	4930	5080	5240	5390	5550	5700	5850	6000	6150	<b>6300</b>		
<b>145</b>	<b>D</b>	7590	8190	8780	9080	9360	9650	9930	10210	10490	10770	11050	11330	<b>11600</b>		
<b>152</b>	<b>S</b>	4640	5010	5370	5560	5730	5910	6080	6250	6420	6590	6760	6930	<b>7100</b>		
<b>148</b>	<b>D</b>	8240	8890	9540	9860	10170	10480	10790	11090	11400	11700	12000	12300	<b>12600</b>		
<b>156</b>	<b>S</b>	5110	5520	5920	6120	6310	6510	6690	6880	7070	7260	7450	7630	7820	<b>8000</b>	
<b>150</b>	<b>D</b>	8560	9240	9910	10240	10560	10890	11210	11530	11850	12160	12470	12780	13090	<b>13400</b>	

# Technical Data

			Tyre Dimensions <sup>(1)</sup>				Max Load			Rim Data		
Size	Goodyear Design	Load Index	Overall Diameter [mm] (+/- 1.5%)	Overall Section Width [mm] (+/- 1.5%)	Static Loaded Radius [mm]	Rolling Circumf. [mm]	Nominal Pressure [bar]	Single Axle Load [kg]	Dual Axle Load [kg]	Recomm. Rim Width	Permitted Rim Width	Min. Dual Spacing
375/90 R 22.5	ETRTO	164	1248	382	573	3806	7,50	10000		11.75	10.50-11.75	
	Omnitrac MSS	164	1244	376	571	3797	7,50	10000		11.75	10.50-11.75	
	Offroad ORD	164	1262	392	580	3852	7,50	10000		11.75	10.50-11.75	
<b>22.5" Sizes – 80 Series</b>												
295/80 R 22.5	ETRTO	152/148	1044	298	487	3184	8,50	7100	12600	9.00	8.25-9.00	335
	FUELMAX S HL GEN-2	154/149	1045	303	486	3200	8,50	7500	13000	8.25	8.25-9.00	326
	FUELMAX D GEN-2	152/148	1052	303	491	3211	8,50	7500	12600	8.25	8.25-9.00	326
	Marathon Coach HL	154/149	1050	307	486	3205	8,50	7500	13000	9.00	8.25-9.00	335
	UltraGrip Coach HL	154/149	1061	306	492	3239	8,50	7500	13000	9.00	8.25-9.00	335
	KMAX S HL GEN-2	154/149	1057	302	491	3217	8,50	7500	13000	9.00	8.25-9.00	335
	KMAX S HL	154/149	1057	302	491	3217	8,50	7500	13000	9.00	8.25-9.00	335
	KMAX D GEN-2	152/148	1060	302	494	3218	8,50	7500	13000	8.25	8.25-9.00	326
	ULTRA GRIP MAX S HL	154/149	1058	305	488	3212	8,50	7500	13000	8.25	8.25-9.00	326
	ULTRA GRIP MAX D	152/148	1060	305	494	3200	8,50	7100	12600	8.25	8.25-9.00	326
	UrbanMax MCA	152/148	1061	298	494	3239	8,50	7100	12600	8.25	8.25-9.00	326
	OMNITRAC S	152/148	1053	309	491	3231	8,50	7100	12600	8.25	8.25-9.00	326
	OMNITRAC D	152/148	1058	308	494	3232	8,50	7100	12600	8.25	8.25-9.00	326
	315/80 R 22.5	ETRTO	156/150	1076	312	500	3282	8,50	8000	13400	9.00	9.00-9.75
FUELMAX S GEN-2		156/150	1082	313	505	3293	8,50	8000	13400	9.00	9.00-9.75	351
FUELMAX D GEN-2		156/150	1083	314	504	3283	8,50	8000	13400	9.00	9.00-9.75	351
Marathon Coach		156/150	1081	315	500	3300	8,50	8000	13400	9.00	9.00-9.75	351
UltraGrip Coach		156/150	1093	314	506	3336	8,50	8000	13400	9.00	9.00-9.75	351
KMAX S HL GEN-2		158/150	1084	313	502	3298	9,00	8500	13400	9.00	9.00-9.75	351
KMAX S GEN-2		156/150	1084	313	502	3298	8,50	8000	13400	9.00	9.00-9.75	351
KMAX D GEN-2		156/150	1089	315	505	3298	8,50	8000	13400	9.00	9.00-9.75	351
ULTRA GRIP MAX S		156/150	1086	314	495	3300	8,50	8000	13400	9.00	9.00-9.75	351
ULTRA GRIP MAX D		156/150	1090	314	496	3289	8,50	8000	13400	9.00	9.00-9.75	351
OMNITRAC S		156/150	1086	314	503	3322	8,50	8000	13400	9.00	9.00-9.75	351
OMNITRAC D		156/150	1092	314	508	3325	8,50	8000	13400	9.00	9.00-9.75	351
OMNITRAC S HEAVY DUTY		156/150				in preparation <sup>(2)</sup>	8,50	8000	13400	9.00	9.00-9.75	351
OMNITRAC D HEAVY DUTY		156/150				in preparation <sup>(2)</sup>	8,50	8000	13400	9.00	9.00-9.75	351
<b>22.5" Sizes – 75 Series</b>												
445/75 R 22.5	ETRTO	170	1240	444	570	3782	8,00	12000		13.00	13.00-14.00	
	Omnitrac MSS	170	1236	451	566	3773	8,00	12000		13.00	13.00-14.00	
<b>22.5" Sizes – 70 Series</b>												
275/70 R 22.5	ETRTO	148/145	958	276	445	2922	9,00	6300	11600	8.25	7.50-8.25	311
	KMAX S	148/145	967	276	452	2965	9,00	6300	11600	7.50	7.50-8.25	303
	KMAX D	148/145	974	276	456	2970	9,00	6300	11600	7.50	7.50-8.25	303
	UltraGrip WTS City	148/145	979	271	459	2988	9,00	6300	11600	7.50	7.50-8.25	303
	UltraGrip WTD City	148/145	977	268	458	2982	9,00	6300	11600	7.50	7.50-8.25	303
	UrbanMax MCA	148/145	976	271	457	2979	9,00	6300	11600	7.50	7.50-8.25	303
	UrbanMax MCA HL	150/145	972	273	457	2976	9,00	6700	11600	7.50	7.50-8.25	303
	UrbanMax MCD* Traction	148/145	976	276	459	2985	9,00	6300	11600	7.50	7.50-8.25	303
	Omnitrac MSS II	148/145	973	275	455	2970	9,00	6300	11600	7.50	7.50-8.25	303
	Marathon LHT II	152/148	963	297	451	2940	9,00	7100	12600	7.50	7.50-8.25	303
305/70 R 22.5	ETRTO	153/150	1000	305	463	3050	9,00	7300	13400	9.00	8.25-9.00	343
	KMAX S	153/150	996	297	465	3062	9,00	7300	13400	8.25	8.25-9.00	334
	KMAX D	153/150	1002	297	467	3058	9,00	7300	13400	8.25	8.25-9.00	334
	Urban MCS *	152/148	1008	301	462	3077	9,00	7100	12600	8.25	8.25-9.00	334
315/70 R 22.5	ETRTO	154/150	1014	312	468	3093	9,00	7500	13400	9.00	9.00-9.75	351

<sup>(1)</sup> Measured tyre dimension using the Goodyear recommended rim

<sup>(2)</sup> For any tyre design not listed or in preparation please use the ETRTO data instead

**Load Capacity per Axle [kg] at Inflation Pressure [bar]**

Load Index	Single / Dual Fitment	Tyre pressure in bar															
		5,00	5,50	6,00	6,25	6,50	6,75	7,00	7,25	7,50	7,75	8,00	8,25	8,50	8,75	9,00	
<b>164</b>	<b>S</b>	7230	7800	8370	8650	8920	9200	9460	9730	<b>10000</b>							
<b>152</b>	<b>S</b>	4640	5010	5370	5560	5730	5910	6080	6250	6420	6590	6760	6930	<b>7100</b>			
<b>148</b>	<b>D</b>	8240	8890	9540	9860	10170	10480	10790	11090	11400	11700	12000	12300	<b>12600</b>			
<b>154</b>	<b>S</b>	4910	5290	5680	5870	6050	6240	6420	6600	6790	6970	7140	7320	<b>7500</b>			
<b>149</b>	<b>D</b>	8500	9180	9840	10170	10490	10820	11130	11450	11760	12070	12380	12690	<b>13000</b>			
<b>156</b>	<b>S</b>	5230	5650	6050	6260	6450	6660	6850	7040	7240	7430	7620	7810	<b>8000</b>			
<b>150</b>	<b>D</b>	8760	9460	10140	10480	10810	11150	11470	11800	12120	12450	12770	13080	<b>13400</b>			
<b>158</b>	<b>S</b>	5310	5730	6150	6350	6550	6750	6950	7150	7350	7540	7740	7930	8120	8310	<b>8500</b>	
<b>150</b>	<b>D</b>	8370	9040	9690	10010	10330	10650	10960	11270	11580	11890	12200	12500	12800	13100	<b>13400</b>	
<b>170</b>	<b>S</b>	8240	8890	9530	9850	10160	10480	10780	11090	11400	11700	<b>12000</b>					
<b>148</b>	<b>S</b>	3940	4250	4550	4710	4860	5010	5150	5300	5440	5590	5730	5880	6020	6160	<b>6300</b>	
<b>145</b>	<b>D</b>	7250	7820	8390	8670	8940	9220	9490	9760	10030	10290	10560	10820	11080	11340	<b>11600</b>	
<b>150</b>	<b>S</b>	4190	4520	4840	5000	5160	5320	5480	5640	5790	5940	6100	6250	6400	6550	<b>6700</b>	
<b>145</b>	<b>D</b>	7250	7820	8390	8670	8940	9220	9490	9760	10030	10290	10560	10820	11080	11340	<b>11600</b>	
<b>152</b>	<b>S</b>	4440	4790	5130	5310	5470	5650	5810	5970	6140	6300	6460	6620	6780	6940	<b>7100</b>	
<b>148</b>	<b>D</b>	7870	8500	9110	9420	9710	10010	10310	10600	10890	11180	11470	11750	12040	12320	<b>12600</b>	
<b>153</b>	<b>S</b>	4560	4920	5280	5460	5630	5800	5970	6140	6310	6480	6640	6810	6970	7140	<b>7300</b>	
<b>150</b>	<b>D</b>	8370	9040	9690	10010	10330	10650	10960	11270	11580	11890	12200	12500	12800	13100	<b>13400</b>	
<b>152</b>	<b>S</b>	4440	4790	5130	5310	5470	5650	5810	5970	6140	6300	6460	6620	6780	6940	<b>7100</b>	
<b>148</b>	<b>D</b>	7870	8500	9110	9420	9710	10010	10310	10600	10890	11180	11470	11750	12040	12320	<b>12600</b>	

# Technical Data

Size	Goodyear Design	Load Index	Tyre Dimensions <sup>(1)</sup>				Nominal Pressure [bar]	Max Load		Rim Data		
			Overall Diameter [mm] (+/- 1.5%)	Overall Section Width [mm] (+/- 1.5%)	Static Loaded Radius [mm]	Rolling Circumf. [mm]		Single Axle Load [kg]	Dual Axle Load [kg]	Recomm. Rim Width	Permitted Rim Width	Min. Dual Spacing
	FUELMAX S HL PERFORMANCE	156/150	1005	314	465	3077	9,00	8000	13400	9.00	9.00-9.75	351
	FUELMAX S HL GEN-2	156/150	1009	313	467	3094	9,00	8000	13400	9.00	9.00-9.75	351
	FUELMAX D PERFORMANCE	154/150	1008	314	468	3082	9,00	7500	13400	9.00	9.00-9.75	351
	FUELMAX D GEN-2	154/150	1013	312	475	3093	9,00	7500	13400	9.00	9.00-9.75	351
	KMAX S HL GEN-2	156/150	1015	314	470	3103	9,00	8000	13400	9.00	9.00-9.75	351
	KMAX D GEN-2	154/150	1016	314	472	3095	9,00	7500	13400	9.00	9.00-9.75	351
	OMNITRAC S	156/150		in preparation <sup>(2)</sup>			9,00	8000	13400	9.00	9.00-9.75	351
	OMNITRAC D	154/150		in preparation <sup>(2)</sup>			9,00	7500	13400	9.00	9.00-9.75	351
	ULTRA GRIP MAX S HL	156/150	1014	314	468	3092	9,00	8000	13400	9.00	9.00-9.75	351
	ULTRA GRIP MAX D	154/150	1018	312	469	3090	9,00	7500	13400	9.00	9.00-9.75	351

## 22.5" Sizes – 65 Series

385/65 R 22.5	ETRTO	160	1072	389	496	3248	9,00	9000		11.75	11.75-12.25	
	FUELMAX S GEN-2	160	1075	381	498	3291	9,00	9000		11.75	11.75-12.25	
	KMAX S GEN-2	160	1078	379	500	3299	9,00	9000		11.75	11.75-12.25	
	Regional RHS II HL	164	1075	393	494	3257	9,00	10000		11.75	11.75-12.25	
	ULTRA GRIP MAX S	160	1079	382	496	3285	9,00	9000		11.75	11.75-12.25	
	OMNITRAC S	160	1077	376	500	3307	9,00	9000		11.75	11.75-12.25	
	FUELMAX T HL	164	1072	388	497	3248	9,00	10000		11.75	11.75-12.25	
	KMAX T GEN-2 HL	164	1085	388	499	3320	9,00	10000		11.75	11.75-12.25	
	KMAX T HL	164	1083	386	498	3281	9,00	10000		11.75	11.75-12.25	
	OMNITRAC T	164	1085	387	504	3288	9,00	10000		11.75	11.75-12.25	
	ULTRA GRIP MAX T HL	164	1078	382	493	3290	9,00	10000		11.75	11.75-12.25	
	ULTRA GRIP MAX T	160	1082	382	498	3278	9,00	9000		11.75	11.75-12.25	
425/65 R 22.5	ETRTO	165	1124	422	518	3406	8,25	10300		12.25	12.25-14.00	
	KMAX T GEN-2	165		in preparation <sup>(2)</sup>			8,25	10300		13.00	12.25-14.00	
	KMAX T	165	1128	419	517	3418	8,25	10300		13.00	12.25-14.00	
445/65 R 22.5	ETRTO	169	1150	444	529	3485	9,00	11600		13.00	13.00-14.00	
	KMAX T GEN-2	169		in preparation <sup>(2)</sup>			9,00	11600		13.00	13.00-14.00	
	KMAX T	169	1157	437	530	3552	9,00	11600		13.00	13.00-14.00	
	Omnitrac MST II	169	1159	434	530	3512	9,00	11600		14.00	13.00-15.00	

## 22.5" Sizes – 60 Series

295/60 R 22.5	ETRTO	150/147	926	292	435	2806	9,00	6700	12300	9.00	9.00-9.75	329
	FUELMAX S GEN-2	150/147	925	289	430	2847	9,00	6700	12300	9.00	9.00-9.75	329
	FUELMAX D GEN-2	150/147		in preparation <sup>(2)</sup>			9,00	6700	12300	9.00	9.00-9.75	329
	KMAX S GEN-2	150/147	927	285	432	2841	9,00	6700	12300	9.00	9.00-9.75	329
	KMAX D GEN-2	150/147		in preparation <sup>(2)</sup>			9,00	6700	12300	9.00	9.00-9.75	329
	ULTRA GRIP MAX S	150/147	929	289	427	2841	9,00	6700	12300	9.00	9.00-9.75	329
	ULTRA GRIP MAX D	150/147	937	289	431	2845	9,00	6700	12300	9.00	9.00-9.75	329
315/60 R 22.5	ETRTO	152/148	950	313	445	2879	9,00	7100	12600	9.75	9.00-9.75	352
	FUELMAX S HL GEN-2	154/148		in preparation <sup>(2)</sup>			9,00	7500	12600	9.00	9.00-9.75	344
	FUELMAX D GEN-2	152/148	960	309	448	2943	9,00	7100	12600	9.00	9.00-9.75	344
	KMAX S HL GEN-2	154/148	954	310	442	2936	9,00	7500	12600	9.00	9.00-9.75	344
	KMAX S HL	154/148	955	307	441	2937	9,00	7500	12600	9.00	9.00-9.75	344
	KMAX S A HL	154/148	954	310	442	2936	9,00	7500	12600	9.00	9.00-9.75	344
	KMAX D GEN-2	152/148	965	307	450	2949	9,00	7100	12600	9.00	9.00-9.75	344
	UrbanMax MCA	152/148	963	316	446	2918	9,00	7100	12600	9.00	9.00-9.75	344
	ULTRA GRIP MAX S HL	154/148	957	307	440	2936	9,00	7500	12600	9.00	9.00-9.75	344
	ULTRA GRIP MAX D	152/148	966	308	444	2939	9,00	7100	12600	9.00	9.00-9.75	344

## 22.5" Sizes – 55 Series

<sup>(1)</sup> Measured tyre dimension using the Goodyear recommended rim

<sup>(2)</sup> For any tyre design not listed or in preparation please use the ETRTO data instead

**Load Capacity per Axle [kg] at Inflation Pressure [bar]**

Load Index	Single / Dual Fitment	Tyre pressure in bar														
		5,00	5,50	6,00	6,25	6,50	6,75	7,00	7,25	7,50	7,75	8,00	8,25	8,50	8,75	9,00
<b>154</b>	<b>S</b>	4690	5060	5420	5610	5780	5960	6130	6310	6480	6650	6830	7000	7160	7330	<b>7500</b>
<b>150</b>	<b>D</b>	8370	9040	9690	10010	10330	10650	10960	11270	11580	11890	12200	12500	12800	13100	<b>13400</b>
<b>156</b>	<b>S</b>	5000	5390	5780	5980	6170	6360	6540	6730	6910	7100	7280	7460	7640	7820	<b>8000</b>
<b>150</b>	<b>D</b>	8370	9040	9690	10010	10330	10650	10960	11270	11580	11890	12200	12500	12800	13100	<b>13400</b>
<b>160</b>	<b>S</b>	5620	6070	6510	6730	6940	7150	7360	7570	7780	7990	8190	8390	8600	8800	<b>9000</b>
<b>164</b>	<b>S</b>	6250	6740	7230	7470	7710	7950	8180	8410	8640	8870	9100	9330	9550	9780	<b>10000</b>
<b>165</b>	<b>S</b>	6900	7450	7980	8250	8510	8780	9030	9290	9540	9800	10050	<b>10300</b>			
<b>169</b>	<b>S</b>	7250	7820	8390	8670	8940	9220	9490	9760	10030	10290	10560	10820	11080	11340	<b>11600</b>
<b>150</b>	<b>S</b>	4190	4520	4840	5010	5160	5330	5480	5640	5790	5940	6100	6250	6400	6550	<b>6700</b>
<b>147</b>	<b>D</b>	7690	8290	8890	9190	9480	9780	10060	10350	10630	10910	11190	11470	11750	12030	<b>12300</b>
<b>152</b>	<b>S</b>	4440	4790	5130	5310	5470	5650	5810	5970	6140	6300	6460	6620	6780	6940	<b>7100</b>
<b>148</b>	<b>D</b>	7870	8500	9110	9420	9710	10010	10310	10600	10890	11180	11470	11750	12040	12320	<b>12600</b>
<b>154</b>	<b>S</b>	4690	5060	5420	5610	5780	5960	6130	6310	6480	6650	6830	7000	7160	7330	<b>7500</b>
<b>148</b>	<b>D</b>	7870	8500	9110	9420	9710	10010	10310	10600	10890	11180	11470	11750	12040	12320	<b>12600</b>

# Technical Data

			Tyre Dimensions <sup>(1)</sup>				Max Load			Rim Data			
Size	Goodyear Design	Load Index	Overall Diameter [mm] (+/- 1.5%)	Overall Section Width [mm] (+/- 1.5%)	Static Loaded Radius [mm]	Rolling Circumf. [mm]	Nominal Pressure [bar]	Single Axle Load [kg]	Dual Axle Load [kg]	Recomm. Rim Width	Permitted Rim Width	Min. Dual Spacing	
295/55 R 22.5	ETRTO	147/145	896	292	420	2733	9,00	6150	11600	9.00	9.00-9.75	329	
	KMAX D GEN-2	147/145	892	291	415	2733	9,00	6150	11600	9.00	9.00-9.75	329	
385/55 R 22.5	ETRTO	160	996	386	456	3028	9,00	9000		12.25	11.75-12.25		
	FUELMAX S PERFORMANCE	160	987	386	464	3033	9,00	9000		11.75	11.75-12.25		
	FUELMAX S GEN-2	160	991	385	457	3045	9,00	9000		11.75	11.75-12.25		
	KMAX S GEN-2	160	993	384	456	3048	9,00	9000		11.75	11.75-12.25		
	ULTRA GRIP MAX S	160	997	383	459	3050	9,00	9000		11.75	11.75-12.25		
	Omnitrac MSD II	160	996	386	457	3018	9,00	9000		11.75	11.75-12.25		
	FUELMAX T	160	996	386	455	3019	9,00	9000		11.75	11.75-12.25		
	KMAX T	160	995	387	457	3015	9,00	9000		11.75	11.75-12.25		
	ULTRA GRIP MAX T	160	995	386	457	3015	9,00	9000		11.75	11.75-12.25		
<b>22.5" Sizes – 50 Series</b>													
355/50 R 22.5	ETRTO	154	928	361	435	2812	9,00	7500		11.75	11.75		
	KMAX S HL	156	930	358	431	2868	9,00	8000		11.75	11.75		
	UltraGrip WTS	154	935	359	433	2833	9,00	7500		11.75	11.75		
375/50 R 22.5	ETRTO	156	948	374	444	2872	9,00	8000		11.75	11.75-12.25		
	Marathon LHS II	156	951	366	440	2882	9,00	8000		11.75	11.75-12.25		
435/50 R 22.5	ETRTO	164	1008	438	460	3074	9,00	10000		14.00	14.00-15.00		
	Marathon LHT	164	1003	434	464	3110	9,00	10000		14.00	14.00-15.00		
<b>22.5" Sizes – 45 Series</b>													
315/45 R 22.5	ETRTO	147/145	856	307			9,00	6150	11600	9.75	9.75	345	
	KMAX D GEN-2	147/145		in preparation <sup>(2)</sup>				9,00	6150	11600	9.75	9.75	345
	KMAX D	147/145	854	298	402	2620	9,00	6150	11600	9.75	9.75	345	
375/45 R 22.5	ETRTO	156	910	372			9,00	8000		12.25	11.75-12.25		
	KMAX S	156	910	361	420	2670	9,00	8000		11.75	11.75-12.25		
455/45 R 22.5	ETRTO	166	982	453	458	2995	9,00	10600		15.00	14.00-15.00		
	UrbanMax MCD Traction	166	985	450	449	2985	9,00	10600		15.00	14.00-15.00		
495/45 R 22.5	ETRTO	169	1018	499	473	3085	9,00	11600		17.00	16.00-17.00		
	Marathon LHD	169	1018	505	471	3085	9,00	11600		17.00	16.00-17.00		
	Omnitrac MSD II	169	1020	502	466	3091	9,00	11600		17.00	16.00-17.00		
<b>22.5" Sizes – 40 Series</b>													
455/40 R 22.5	ETRTO	160	936	453	439	2850	9,00	9000		15.00	15.00-16.00		
	Marathon LHT+	160	930	436	436	2836	9,00	9000		15.00	15.00-16.00		
<b>24" Sizes – Standard Series</b>													
12.00 R 24	ETRTO	160/156	1226	313	567	3739	8,50	9000	16000	8.50	8.50-9.00	360	
	Omnitrac MSS II	160/156	1219	315	566	3694	8,50	9000	16000	8.50	8.50-9.00	360	
	Omnitrac MSD II+	160/156	1232	315	572	3733	8,50	9000	16000	8.50	8.50-9.00	360	
	Offroad ORD	160/156	1235	312	571	3770	8,50	9000	16000	8.50	8.50-9.00	360	
<b>24" Sizes – 95 Series</b>													
325/95 R 24	ETRTO	162/160	1228	325	567	3739	8,50	9500	18000	9.00	8.50-10.00	374	
	OMNITRAC S	162/160	1222	318	566	3736	8,50	9500	18000	9.00	8.50-10.00	374	
	OMNITRAC S HEAVY DUTY	162/160		in preparation <sup>(2)</sup>				8,50	9500	18000	9.00	8.50-10.00	374
	OMNITRAC D HEAVY DUTY	162/160		in preparation <sup>(2)</sup>				8,50	9500	18000	9.00	8.50-10.00	374
	Omnitrac MSS II	162/160	1220	312	564	3724	8,50	9500	18000	9.00	8.50-10.00	374	
	Omnitrac MSD II+	162/160	1229	312	570	3752	8,50	9500	18000	9.00	8.50-10.00	374	
	Offroad ORD	162/160	1233	319	571	3764	8,50	9500	18000	9.00	8.50-10.00	374	

<sup>(1)</sup> Measured tyre dimension using the Goodyear recommended rim

<sup>(2)</sup> For any tyre design not listed or in preparation please use the ETRTO data instead



**Load Capacity per Axle [kg] at Inflation Pressure [bar]**

Load Index	Single / Dual Fitment	Tyre pressure in bar														
		5,00	5,50	6,00	6,25	6,50	6,75	7,00	7,25	7,50	7,75	8,00	8,25	8,50	8,75	9,00
<b>147</b>	<b>S</b>	3840	4150	4450	4600	4740	4890	5030	5170	5320	5460	5600	5740	5880	6010	<b>6150</b>
<b>145</b>	<b>D</b>	7250	7820	8390	8670	8940	9220	9490	9760	10030	10290	10560	10820	11080	11340	<b>11600</b>
<b>160</b>	<b>S</b>	5620	6070	6510	6730	6940	7150	7360	7570	7780	7990	8190	8390	8600	8800	<b>9000</b>
<b>154</b>	<b>S</b>	4690	5060	5420	5610	5780	5960	6130	6310	6480	6650	6830	7000	7160	7330	<b>7500</b>
<b>156</b>	<b>S</b>	5000	5390	5780	5980	6170	6360	6540	6730	6910	7100	7280	7460	7640	7820	<b>8000</b>
<b>156</b>	<b>S</b>	5000	5390	5780	5980	6170	6360	6540	6730	6910	7100	7280	7460	7640	7820	<b>8000</b>
<b>164</b>	<b>S</b>	6250	6750	7230	7470	7710	7950	8180	8420	8650	8880	9110	9330	9560	9780	<b>10000</b>
<b>147</b>	<b>S</b>	3840	4150	4450	4590	4740	4885	5030	5175	5315	5460	5600	5735	5875	6010	<b>6150</b>
<b>145</b>	<b>D</b>	7250	7820	8390	8660	8940	9230	9490	9760	10030	10290	10560	10820	11080	11340	<b>11600</b>
<b>156</b>	<b>S</b>	50200	5400	5780	5980	6170	6360	6540	6730	6910	7100	7280	7460	7640	7820	<b>8000</b>
<b>166</b>	<b>S</b>	6620	7150	7660	7920	8170	8430	8670	8920	9160	9400	9650	9890	10130	10360	<b>10600</b>
<b>169</b>	<b>S</b>	7250	7820	8390	8670	8940	9220	9490	9760	10030	10290	10560	10820	11080	11340	<b>11600</b>
<b>160</b>	<b>S</b>	5630	6070	6510	6730	6940	7150	7370	7580	7780	7990	8200	8400	8600	8800	<b>9000</b>
<b>160</b>	<b>S</b>	5890	6350	6810	7040	7260	7490	7710	7920	8140	8360	8570	8790	<b>9000</b>		
<b>156</b>	<b>D</b>	10470	11290	12110	12510	12910	13310	13700	14090	14480	14860	15240	15620	<b>16000</b>		
<b>162</b>	<b>S</b>	6210	6710	7190	7430	7670	7910	8130	8360	8590	8820	9050	9280	<b>9500</b>		
<b>160</b>	<b>D</b>	11770	12710	13620	14070	14520	14970	15410	15850	16280	16720	17150	17580	<b>18000</b>		





# Retread Information and Regrooving Guidelines.

## Why retreading?

### REASON 1

## Retreading gives a tyre multiple lives

New Goodyear Tyres feature high quality casings, produced with the latest technology and materials, and an intelligent construction. Excellent durability and damage resistance properties further add to their performance. Thanks to these features, Goodyear Tyres last longer, plus tyre life does not need to end after it is worn! Our new tyres are made as an ideal basis for regrooving and retreading.

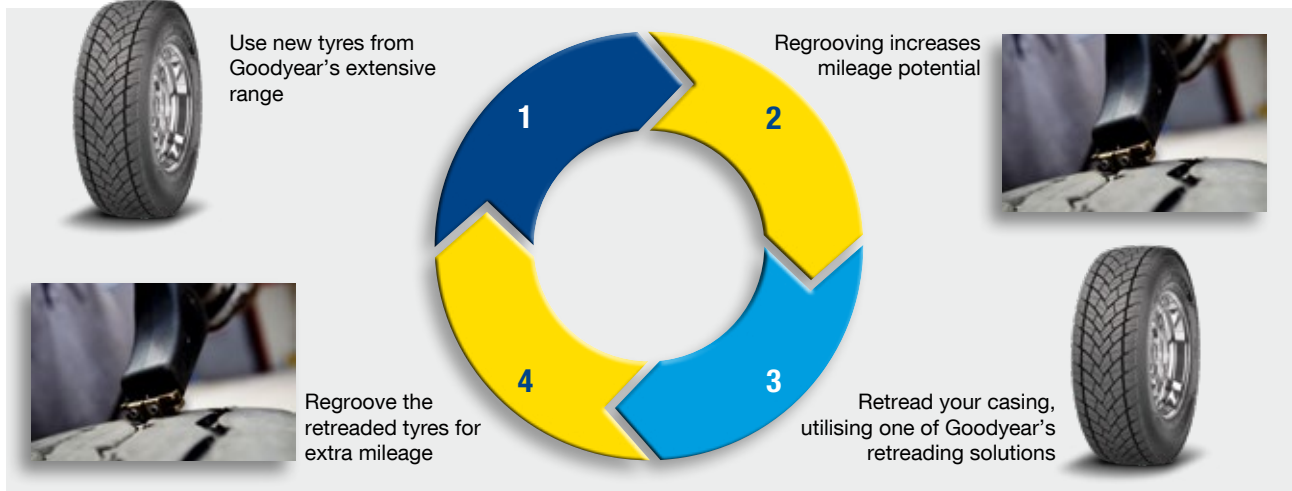

### REASON 2

## Retreads substantially reduce operating costs

When compared to buying new tyres again after the first lifecycle of a new tyre, retreading and regrooving offers a substantial cost reduction. On the one hand, the price of a Goodyear retreaded tyre lies between 50% and 70% than that of a new tyre. On the other hand, it increases mileage. Moreover, by using more retreads, increasing the retread ratio and increasing the use of suitable casings of worn tyres, fleets can reduce their overall annual operational costs even further.

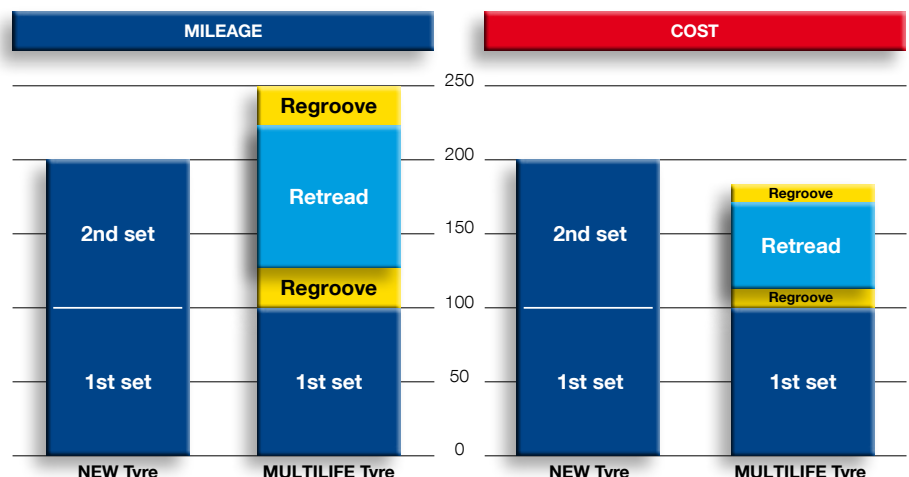

## REASON 3

### Goodyear Dunlop Retread performance is similar to new tyres

It may come as a surprise that the performance of Goodyear retreaded tyres is similar to that of new tyres. However, knowing that the team that develops Goodyear new tyres, also develops the retreads, and that the design and pattern of retreads is identical to the new tyre, it simply makes sense.

Moreover, the compound used is carefully selected to ensure top-level performance, as you can expect from any premium Goodyear product.



## REASON 4

### Retreading has a positive impact on the environment

Prolonging the lifespan of a tyre by retreading has a positive impact on the environment in several ways. Retreads use fewer raw materials, produce less waste (both during manufacturing and because casings are re-used) and mean less energy waste.

For example, producing a retread consumes about 66% less oil than production of a new tyre.



---

# Regrooving Guidelines

**Depending on conditions of use and maintenance, Goodyear's high-quality tyre casings can give each tyre multiple lives (new, regrooved, retread, regrooved retread) lowering operating costs.**

## Regrooving basics

1. A regrooved tyre is a tyre, either new or retreaded, on which the tread pattern has been renewed or a new tread pattern has been produced by cutting into the tread deeper than the original moulded groove depth.
2. The regrooving of truck tyres should be entrusted solely to fully trained operators.
3. Only proven regrooving tools with electrically heated blades should be used.
4. A minimum of remaining undertread rubber is essential to avoid damage at the top breaker belt, groove cracking and/or stone damage.
5. If regrooved according to the recommendations outlined in this manual, Goodyear tyres can, in principle, be mounted on all wheel positions. However, since it has become standard practice for users to normally fit new tyres on front axles, the regrooved tyres will usually be mounted on the rear axles or trailer positions.
6. Tyres which are heavily damaged in the tread area (e.g. rib tearing, multiple cutting and chipping) should not be regrooved but retreaded.

All tyres that are marked 'Regroovable' in the sidewall areas have extra undertread thickness for regrooving purposes.

## Regrooving recommendations

1. Under NO circumstances should the tyre be completely worn before regrooving. It is strongly recommended to regroove when 3 to 6 mm of the original design is still left.
2. Determine the blade setting depth for each individual tyre as follows:
  - a) Measure the remaining groove depth AT THE POINT OF LOWEST TREAD DEPTH;
  - b) Set the blade in the cutter head to the 'minimum remaining groove depth' + 3 mm maximum regrooving depth. This will maintain a 3 mm gauge under the regrooved tread.
3. While regrooving, hold the cutter so that the underside of the cutting head is flush against the tread surface.
4. The maximum regrooving depth for all Goodyear tyres is 3 mm.
5. If the wear is irregular, probing of the remaining undertread gauge is necessary to ensure that 3 mm of undertread will remain after regrooving.

## Regrooving Goodyear remould tyres

Provided that the retreading process is on Goodyear casings carried out by Goodyear Authorised Retreader, Goodyear remould tyres may be regrooved to the same pattern as the new tyre, with a maximum regrooving depth of 3 mm.

## Regrooving parameters

Regroove Goodyear truck tyres when there is still sufficient tread depth. Suggested remaining tread depths are: 3-4 mm for regular highway use; 5-6 mm in operating conditions where penetration damage is likely.

Regrooving depth indicators are moulded into the tyre design. They allow regrooving tools to be set to the optimum depth.

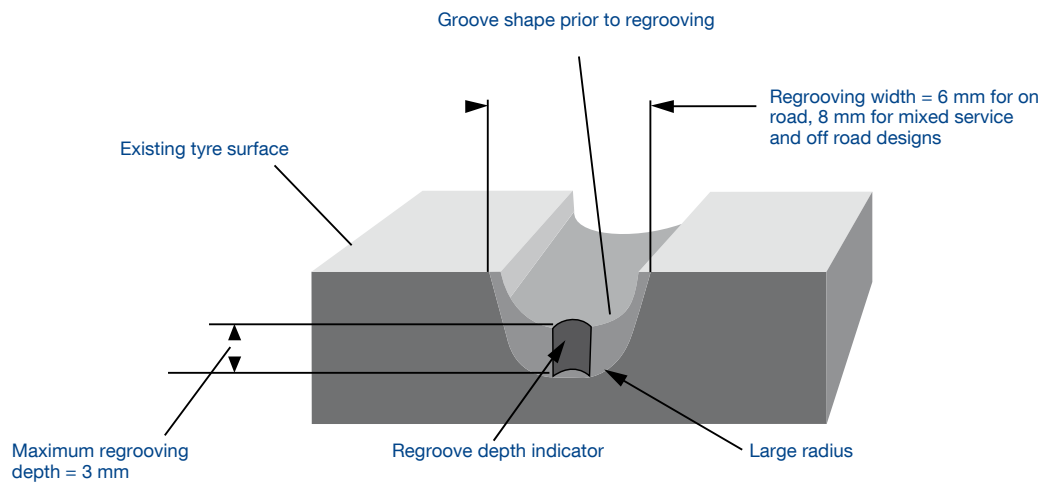

# On Road Fuel Efficient

## FUELMAX S GEN-2 5-rib

New tyre tread

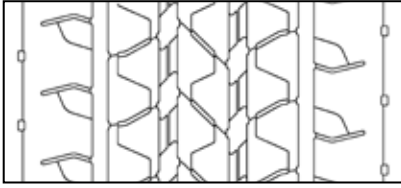

80% worn

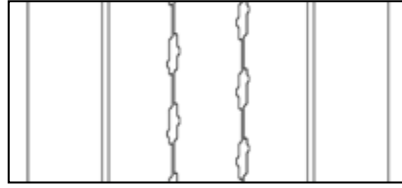

Regrooved tyre



Maximum regrooving depth 3 mm, regrooving width 6 mm. Retreadable by Goodyear TreadMax.

## FUELMAX S GEN-2 6-rib

New tyre tread

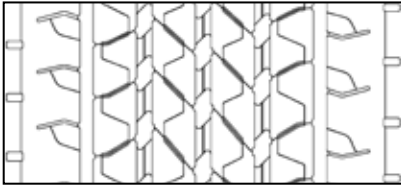

80% worn

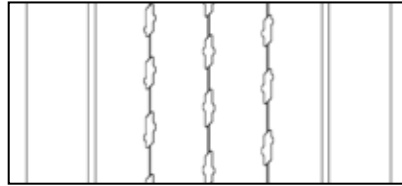

Regrooved tyre



Maximum regrooving depth 3 mm, regrooving width 6 mm. Retreadable by Goodyear TreadMax.

## FUELMAX S PERFORMANCE 315/70R22.5

New tyre tread

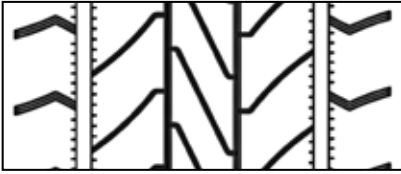

80% worn

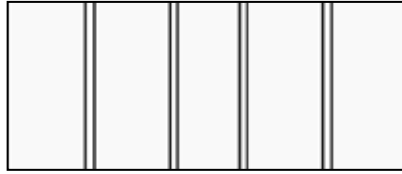

Regrooved tyre

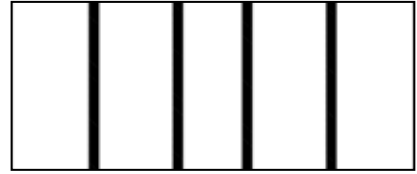

Maximum regrooving depth 3 mm, regrooving width 6 mm. Retreadable by Goodyear TreadMax.

## FUELMAX S PERFORMANCE 385/55R22.5

New tyre tread

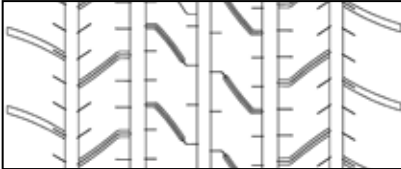

80% worn



Regrooved tyre



Maximum regrooving depth 3 mm, regrooving width 6 mm. Retreadable by Goodyear TreadMax.

## FUELMAX D GEN-2

New tyre tread



80% worn



Regrooved tyre



Maximum regrooving depth 3 mm, regrooving width 6 mm. Retreadable by Goodyear TreadMax.

## FUELMAX D PERFORMANCE

New tyre tread

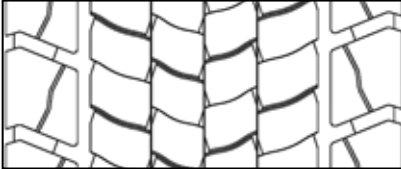

80% worn

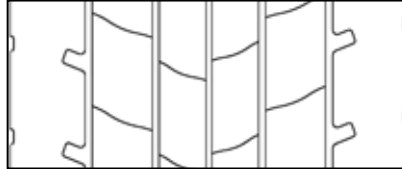

Regrooved tyre



Maximum regrooving depth 3 mm, regrooving width 6 mm. Retreadable by Goodyear TreadMax.



# On Road Fuel Efficient

## FUELMAX T 19.5" and 22.5"

New tyre tread

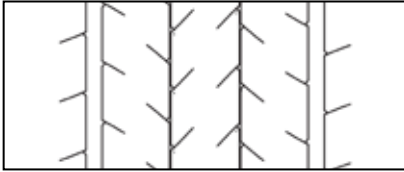

80% worn

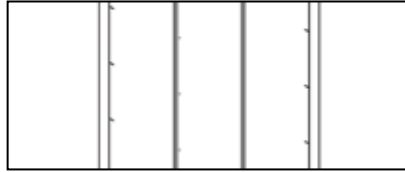

Regrooved tyre



Maximum regrooving depth 3 mm, regrooving width 6-8 mm. Retreadable by Goodyear TreadMax.

## FUELMAX T 435/50R19.5

New tyre tread

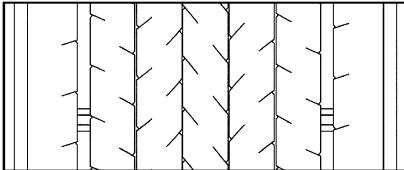

80% worn

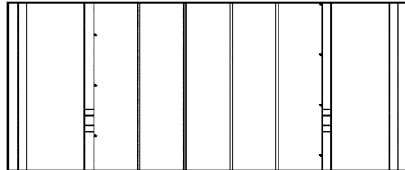

Regrooved tyre

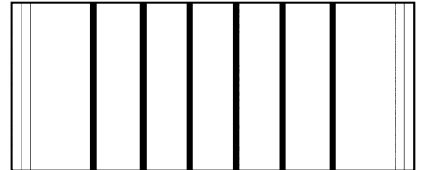

Maximum regrooving depth 3 mm, regrooving width 6-8 mm. Retreadable by Goodyear TreadMax.

## Marathon LHS II 50 series

New tyre tread

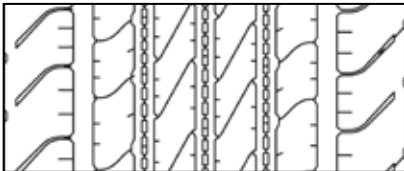

80% worn

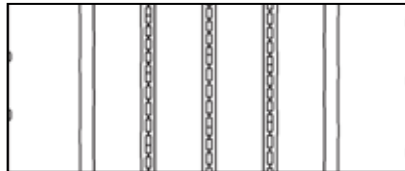

Regrooved tyre



Maximum regrooving depth 3 mm, regrooving width 6-8 mm. Retreadable by Goodyear TreadMax.

## Marathon LHD 495/45R22.5

New tyre tread

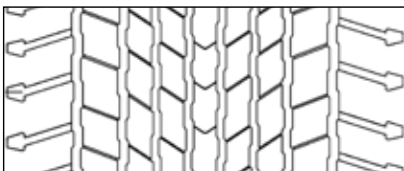

80% worn



Regrooved tyre



Maximum regrooving depth 3 mm, regrooving width 6 mm. Retreadable by Goodyear TreadMax.

## Marathon LHT

New tyre tread

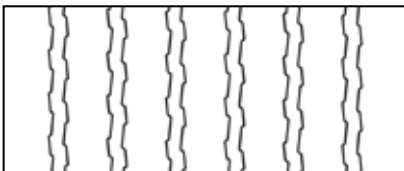

80% worn



Regrooved tyre



Maximum regrooving depth 3 mm, regrooving width 6 mm. Retreadable by Goodyear TreadMax.

# On Road Mileage

## KMAX S GEN-2 5 rib

New tyre tread

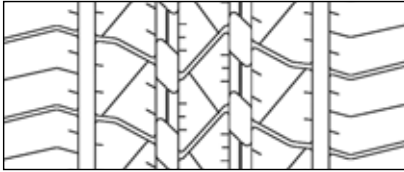

80% worn

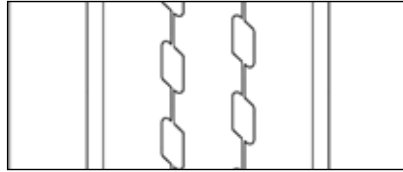

Regrooved tyre



Maximum regrooving depth 3 mm, regrooving width 6-8 mm. Retreadable by Goodyear TreadMax.

## KMAX S GEN-2 6 rib

New tyre tread

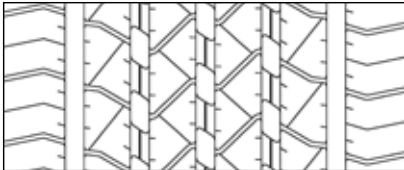

80% worn

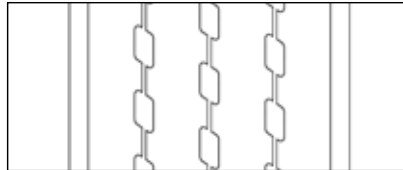

Regrooved tyre

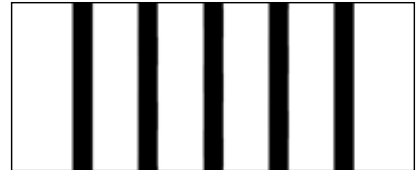

Maximum regrooving depth 3 mm, regrooving width 8 mm. Retreadable by Goodyear TreadMax.

## KMAX S 22.5"

New tyre tread

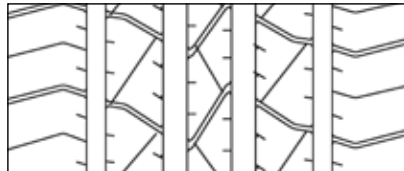

80% worn

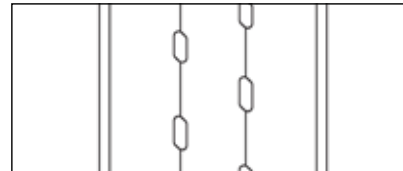

Regrooved tyre



Maximum regrooving depth 3 mm, regrooving width 6-8 mm. Retreadable by Goodyear TreadMax.

## KMAX S A 315/60R22.5

New tyre tread

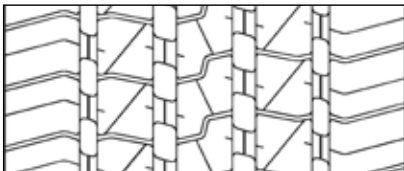

80% worn

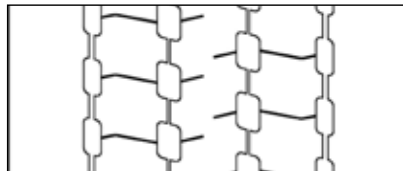

Regrooved tyre



Maximum regrooving depth 3 mm, regrooving width X mm. Retreadable by Goodyear TreadMax.

## KMAX D GEN-2

New tyre tread



80% worn



Regrooved tyre



Maximum regrooving depth 3 mm, regrooving width 6 mm.

## KMAX D 22.5"

New tyre tread



80% worn

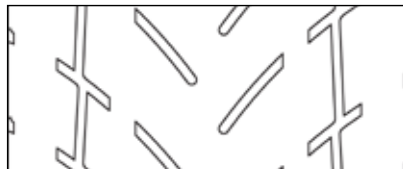

Regrooved tyre



Maximum regrooving depth 3 mm, regrooving width 6-8 mm. Retreadable by Goodyear TreadMax.

# On Road Mileage

## KMAX T GEN-2

New tyre tread

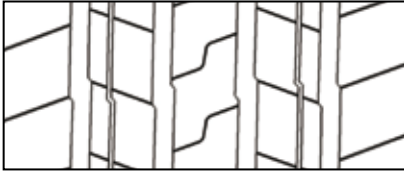

80% worn



Regrooved tyre



Maximum regrooving depth 3 mm, regrooving width 6-8 mm. Retreadable by Goodyear TreadMax.

## KMAX T 19.5" and 22.5"

New tyre tread

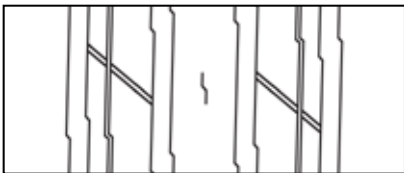

80% worn

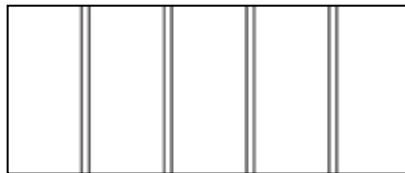

Regrooved tyre



Maximum regrooving depth 3 mm, regrooving width 6-8 mm. Retreadable by Goodyear TreadMax.

## KMAX S 17.5" and 19.5" 5 rib

New tyre tread



80% worn



Regrooved tyre



Maximum regrooving depth 3 mm, regrooving width 6 mm. Retreadable by Goodyear TreadMax.

## KMAX S 17.5" 4-rib

New tyre tread



80% worn

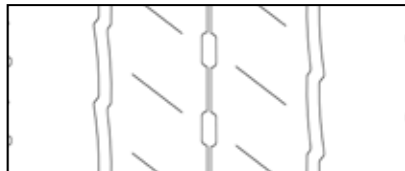

Regrooved tyre

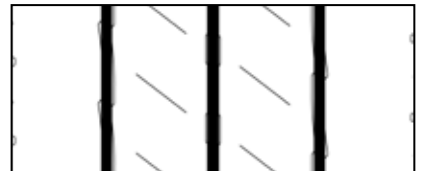

Maximum regrooving depth 3 mm, regrooving width 6 mm.

## KMAX D 17.5" and 19.5"

New tyre tread



80% worn

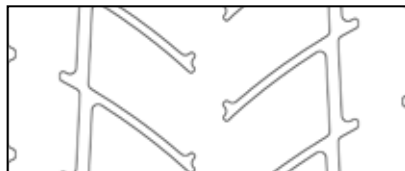

Regrooved tyre



Maximum regrooving depth 3 mm, regrooving width 6 mm. Retreadable by Goodyear TreadMax.

## KMAX T lpt 17.5" and 19.5"

New tyre tread

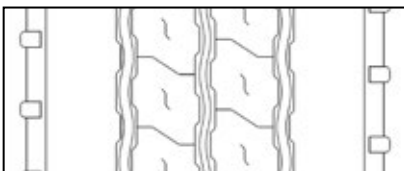

80% worn

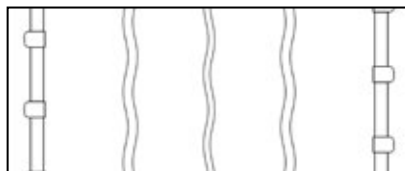

Regrooved tyre

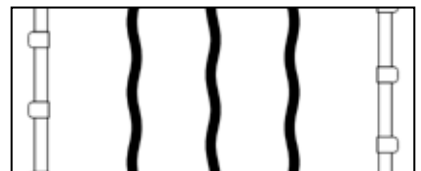

Maximum regrooving depth 3 mm, regrooving width 6-8 mm. Retreadable by Goodyear TreadMax.

# On Road Mileage

## Regional RHS II 22.5"

New tyre tread

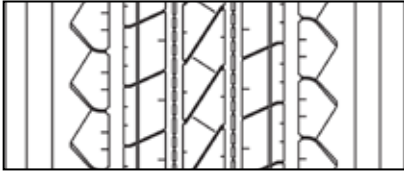

80% worn

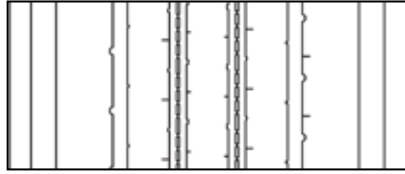

Regrooved tyre



Maximum regrooving depth 3 mm, regrooving width 6-8 mm. Retreadable by Goodyear TreadMax.

## Regional RHD II 22.5"

New tyre tread

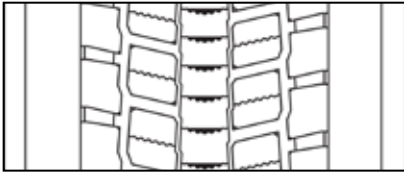

80% worn

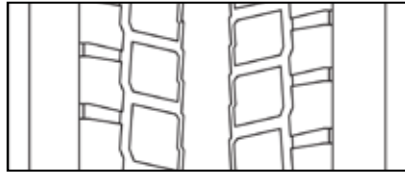

Regrooved tyre

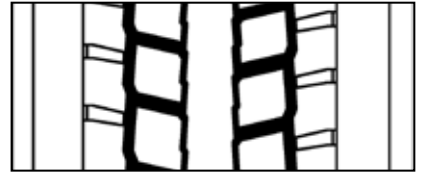

Maximum regrooving depth 3 mm, regrooving width 6-8 mm. Retreadable by Goodyear TreadMax.

# Mixed Service

## OMNITRAC S 22.5"

New tyre tread

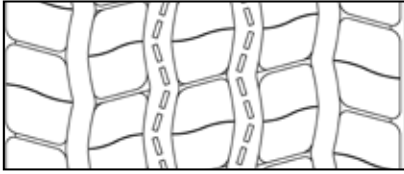

80% worn

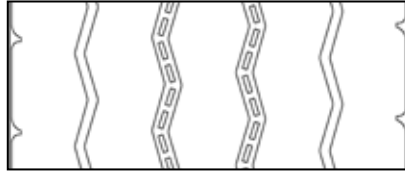

Regrooved tyre



Maximum regrooving depth 3 mm, regrooving width 5-10 (5-rib) / 9-11 (4-rib) mm. Retreadable by Goodyear TreadMax.

O = Regrooving depth indicators

## OMNITRAC S 24"

New tyre tread



80% worn

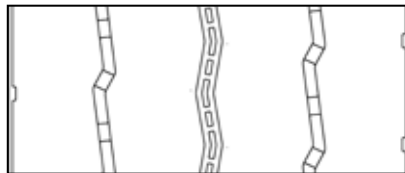

Regrooved tyre



Maximum regrooving depth 3 mm, regrooving width 7-11 mm. Retreadable by Goodyear TreadMax.

O = Regrooving depth indicators

## OMNITRAC D

New tyre tread



80% worn

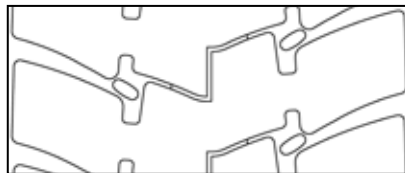

Regrooved tyre



Maximum regrooving depth 3 mm, regrooving width 9-13.5 mm. Retreadable by Goodyear TreadMax.

O = Regrooving depth indicators

## OMNITRAC S HEAVY DUTY

New tyre tread



80% worn

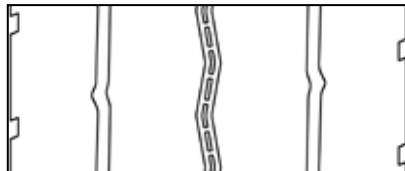

Regrooved tyre



Maximum regrooving depth 3 mm, regrooving width 9-10 mm. Retreadable by Goodyear TreadMax.

O = Regrooving depth indicators

## OMNITRAC D HEAVY DUTY

New tyre tread



80% worn

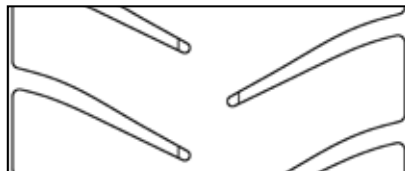

Regrooved tyre



Maximum regrooving depth 3 mm, regrooving width 9 mm. Retreadable by Goodyear TreadMax.

## Omnitrac MSS II 4 ribs

New tyre tread

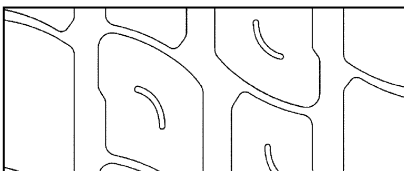

80% worn

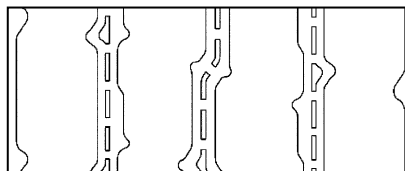

Regrooved tyre

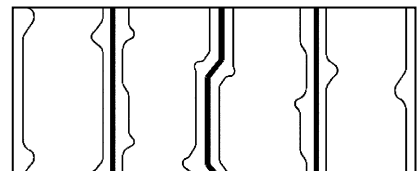

Maximum regrooving depth 3 mm, regrooving width 6-8 mm. Retreadable by Goodyear TreadMax.

O = Regrooving depth indicators

# Mixed Service

## Omnitrac MSS II 5 ribs

New tyre tread

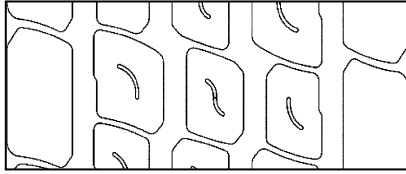

80% worn

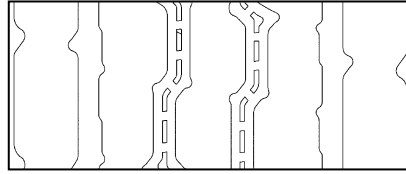

Regrooved tyre

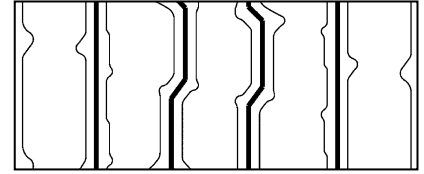

Maximum regrooving depth 3 mm, regrooving width 6-8 mm. Retreadable by Goodyear TreadMax.

O = Regrooving depth indicators

## Omnitrac MSS 375/90R22.5 and 445/75R22.5

New tyre tread

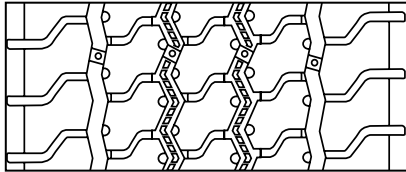

80% worn

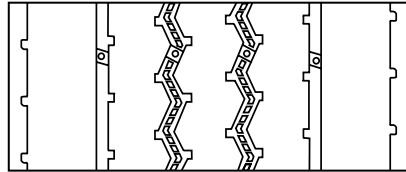

Regrooved tyre

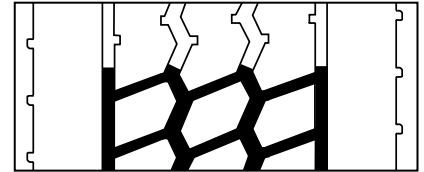

Maximum regrooving depth 3 mm, regrooving width 6-8 mm. Retreadable by Goodyear TreadMax.

O = Regrooving depth indicators

## Omnitrac MSD II 20", 22.5" and 24"

New tyre tread

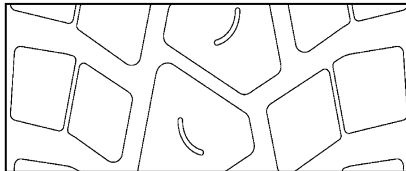

80% worn

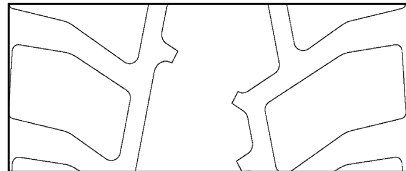

Regrooved tyre



Maximum regrooving depth 3 mm, regrooving width 6-8 mm. Retreadable by Goodyear TreadMax.

## Omnitrac MSD II 385/55R22.5

New tyre tread

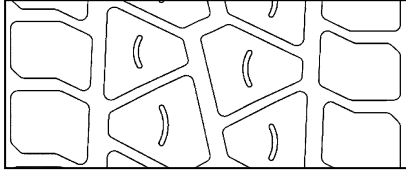

80% worn

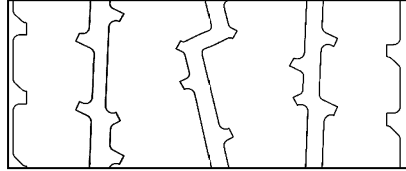

Regrooved tyre



Maximum regrooving depth 3 mm, regrooving width 6-8 mm. Retreadable by Goodyear TreadMax.

## Omnitrac MSD II 495/45R22.5

New tyre tread

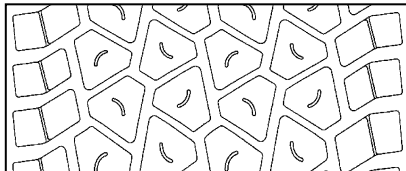

80% worn

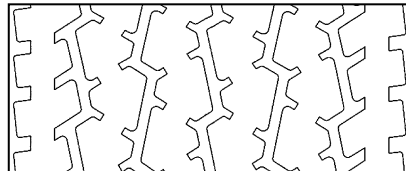

Regrooved tyre

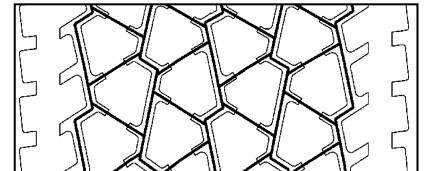

Maximum regrooving depth 3 mm, regrooving width 6-8 mm. Retreadable by Goodyear TreadMax.

## OMNITRAC T

New tyre tread

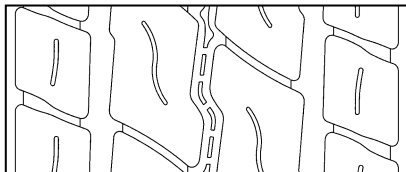

80% worn



Regrooved tyre

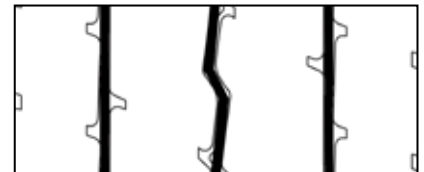

Maximum regrooving depth 3 mm, regrooving width 8 mm. Retreadable by Goodyear TreadMax.

O = Regrooving depth indicators

# Offroad

## Offroad ORS

New tyre tread

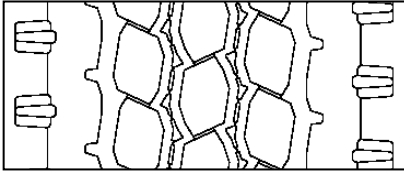

80% worn

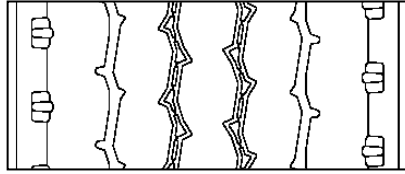

Regrooved tyre

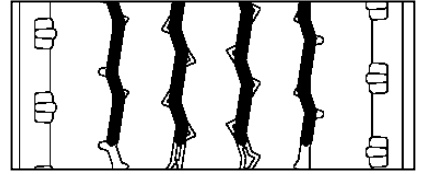

Maximum regrooving depth 3 mm, regrooving width 6-8 mm. Retreadable by Goodyear TreadMax.

## Offroad ORD 22.5" and 24"

New tyre tread

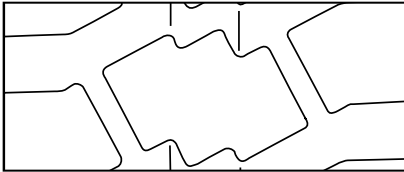

80% worn

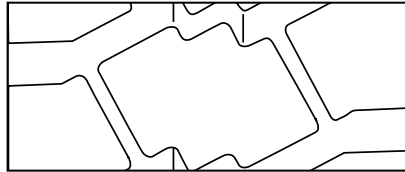

Regrooved tyre



Maximum regrooving depth 3 mm, regrooving width 8-10 mm. Retreadable by Goodyear TreadMax.

## Offroad ORD 365/85R20 and 375/90R22.5

New tyre tread

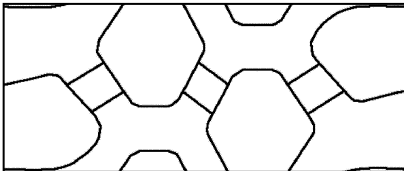

80% worn

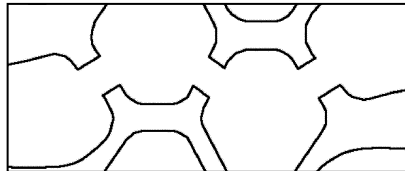

Regrooved tyre



Maximum regrooving depth 3 mm, regrooving width 8-10 mm. Retreadable by Goodyear TreadMax.

## Offroad ORD 14.00R20

New tyre tread



80% worn



Regrooved tyre



Maximum regrooving depth 3 mm, regrooving width 8-10 mm. Retreadable by Goodyear TreadMax.

# Urban

## UrbanMax MCA 19.5" and 22.5"

New tyre tread

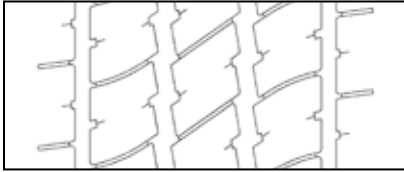

80% worn

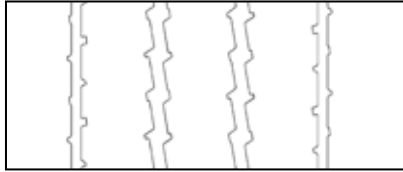

Regrooved tyre

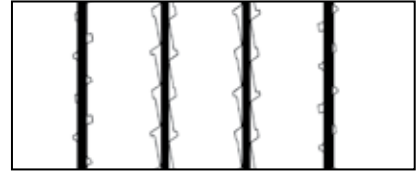

Maximum regrooving depth 3 mm, regrooving width 6-8 mm. Retreadable by Goodyear TreadMax.

## UrbanMax MCS

New tyre tread

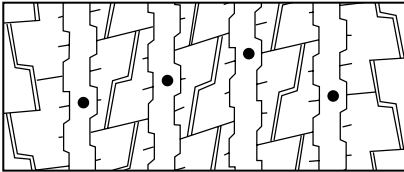

80% worn

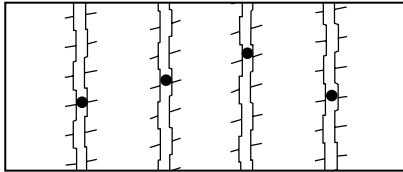

Regrooved tyre

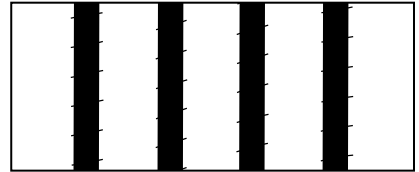

Maximum regrooving depth 3 mm, regrooving width 8-10 mm. Retreadable by Goodyear TreadMax.

## UrbanMax MCD Traction

New tyre tread



80% worn



Regrooved tyre

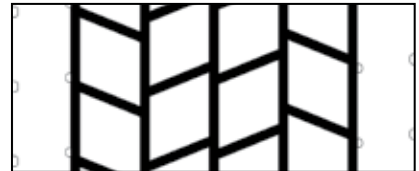

Maximum regrooving depth 3 mm, regrooving width 6-8 mm. Retreadable by Goodyear TreadMax.

## UrbanMax MCD Super Single

New tyre tread



80% worn

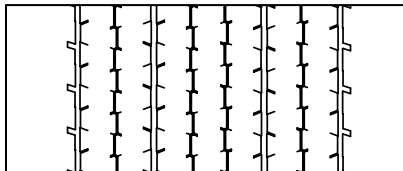

Regrooved tyre

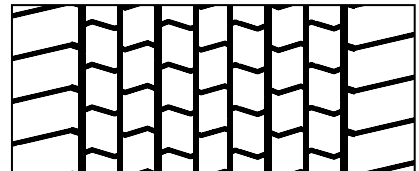

Maximum regrooving depth 3 mm, regrooving width 6-8 mm. Retreadable by Goodyear TreadMax.



# Coach

## Marathon Coach

New tyre tread

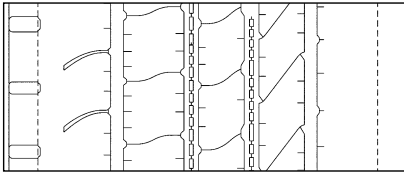

80% worn

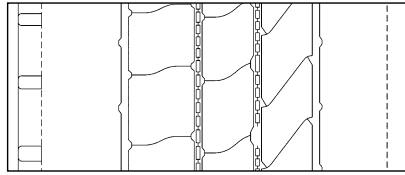

Regrooved tyre

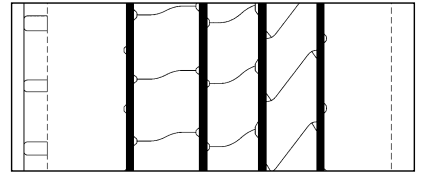

Maximum regrooving depth 3 mm, regrooving width 6-8 mm. Retreadable by Goodyear TreadMax.

## ULTRA GRIP Coach

New tyre tread

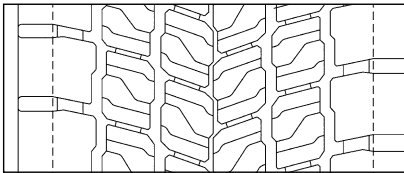

80% worn

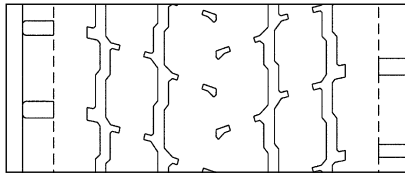

Regrooved tyre

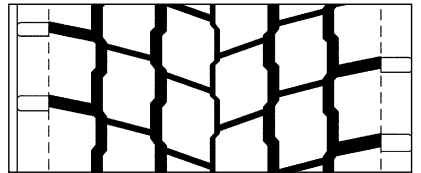

Maximum regrooving depth 3 mm, regrooving width 6-10 mm. Retreadable by Goodyear TreadMax.

# Winter

## ULTRA GRIP MAX S

New tyre tread

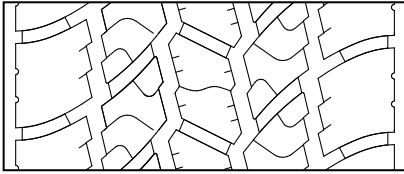

80% worn

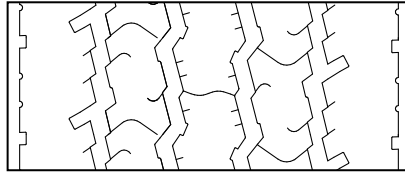

Regrooved tyre

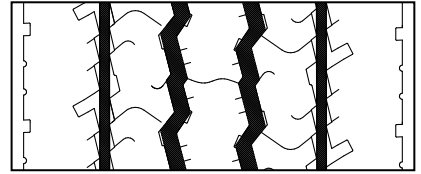

Maximum regrooving depth 3 mm, regrooving width 6-8 mm. Retreadable by Goodyear TreadMax.

## ULTRA GRIP MAX D

New tyre tread

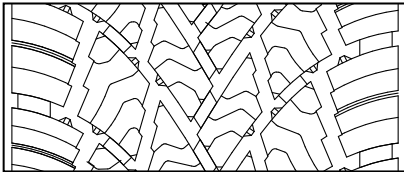

80% worn

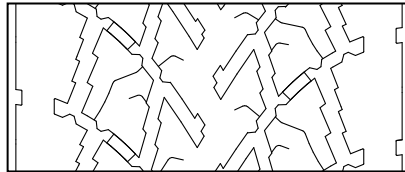

Regrooved tyre



Maximum regrooving depth 3 mm, regrooving width 6-8 mm. Retreadable by Goodyear TreadMax.

## ULTRA GRIP MAX T

New tyre tread

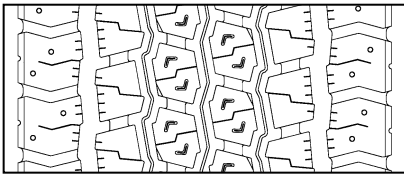

80% worn

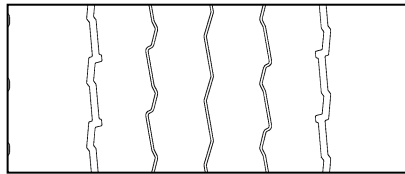

Regrooved tyre

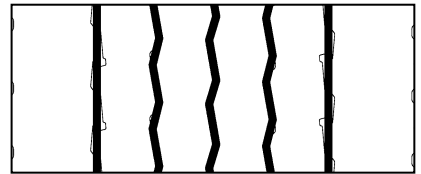

Maximum regrooving depth 3 mm, regrooving width 6-8 mm. Retreadable by Goodyear TreadMax.

## UltraGrip WTS 5-rib

New tyre tread

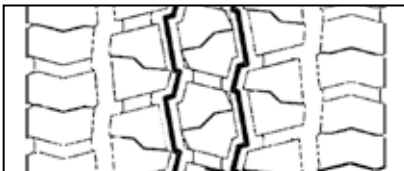

80% worn

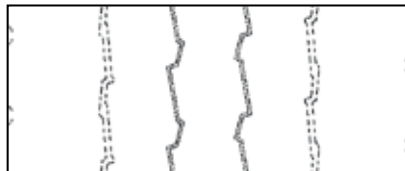

Regrooved tyre

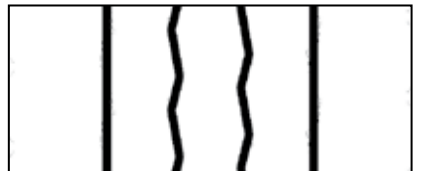

Maximum regrooving depth 3 mm, regrooving width 6-8 mm. Retreadable by Goodyear TreadMax.

## UltraGrip WTS 6-rib

New tyre tread

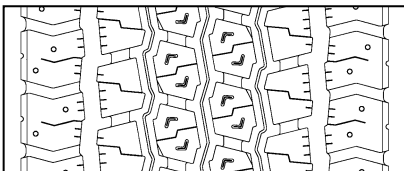

80% worn

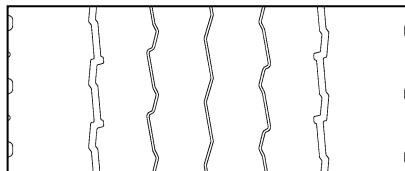

Regrooved tyre

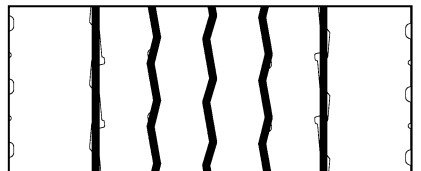

Maximum regrooving depth 3 mm, regrooving width 6-10 mm. Retreadable by Goodyear TreadMax.

# Winter

## UltraGrip WTD 22.5"

New tyre tread

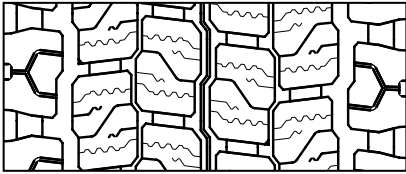

80% worn

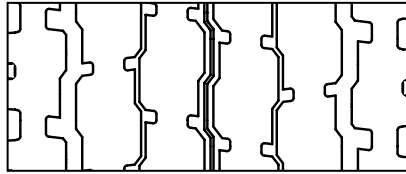

Regrooved tyre

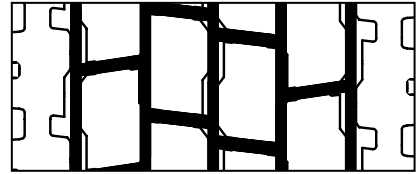

Maximum regrooving depth 3 mm, regrooving width 6-10 mm. Retreadable by Goodyear TreadMax.

## UltraGrip WTT 19.5"

New tyre tread

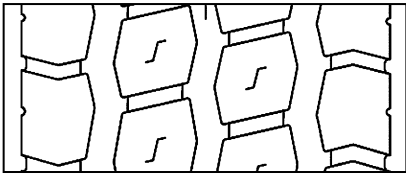

80% worn

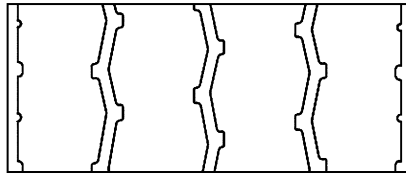

Regrooved tyre

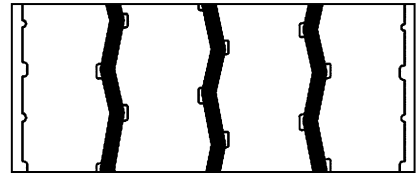

Maximum regrooving depth 3 mm, regrooving width 6-8 mm. Retreadable by Goodyear TreadMax.





# Tyre Technology.



# Tyre construction and tyre terminology

Truck tyres are a high value investment whose performance potential can be dramatically influenced by a multitude of service parameters – which can be globally identified as operating and maintenance conditions. In other words, the true cost per kilometre is not only a function of the tyre quality and price, but is primarily a direct consequence of the actual running conditions of the tyre. In order to be able to optimise these conditions, it is essential to first of all be familiar with the construction characteristics of a tyre and to understand its mechanical properties.

It will also be advisable to have a basic knowledge of vehicle dynamics and to recognise the importance of environmental factors such as road design and ambient temperature.

This brochure is designed to convey these elementary rules and guidelines and to therefore help minimize fleet operating expenses. For further clarifications and updated facts and figures, please consult with your Goodyear truck tyre specialist.

## Tyre construction

The commercially available tyre is a composite product, made up from rubber compounds and textile, steel synthetic reinforcements. The major components of the Goodyear radial ply, steel carcass and belt tyre are described below.

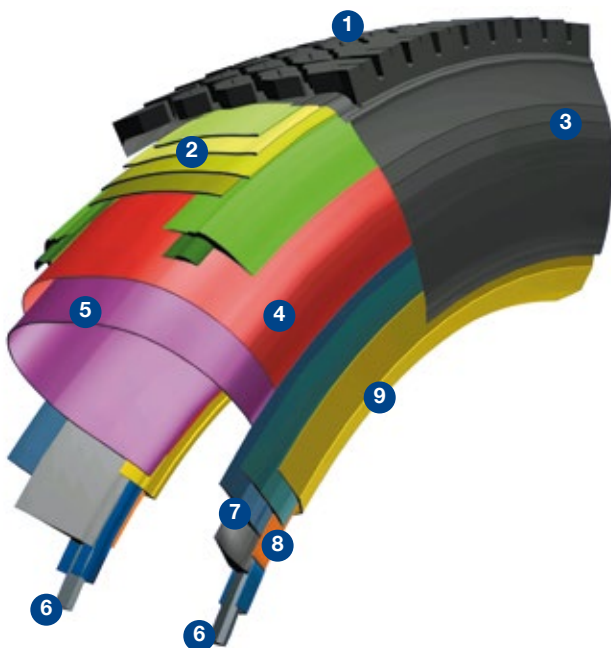

Tube-Type

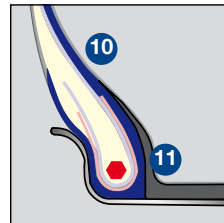

### Features

- 1 Tread
- 2 Belt Package
- 3 Sidewall
- 4 Ply
- 5 Innerliner
- 6 Bead Bundle
- 7 Apexes
- 8 Chipper
- 9 Chafer
- 10 Tube\*
- 11 Flap\*

\* Only applicable to tube type tyres

## Tyre terminology

- **Tread**  
Provides primarily traction and wear and protects the carcass underneath.
- **Belt**  
Multiple, low angle, steel cord layers provide strength to the tyre, stabilise the tread and prevent penetrations into the carcass.
- **Sidewall**  
Provides protection for the ply and withstands flexing and weathering.
- **Ply**  
The radial (90°) ply transmits all load, braking and steering forces between the wheel and the road and withstands the burst loads of the tyre under operating pressure.
- **Innerliner**  
A layer of rubber in tubeless tyres specially compounded to prevent loss of air.
- **Bead bundle**  
The steel bead bundle properly seats and seals the tyre on the rim and maintains it in position.
- **Apex**  
Rubber filler in the bead and lower sidewall area to provide progressive transition from the stiff bead area into the flexible sidewall.
- **Chafer**  
A layer of hard rubber that resists erosion of the bead zone by the rim flange.
- **Tube\***  
A separate air chamber, compounded to prevent loss of air, inserted into tube-type tyres.
- **Flap\***  
A rubber band placed between tube and rim. Protects the tube from chafing and prevents damage to the tube by the rim.

\*Only applicable to tube type tyres.

## Tyre dimension definitions

Tyre companies throughout the world are members of regional tyre manufacturers associations (ETRTO for Europe), which establish tyre dimensions and tolerances, load carrying capacities and inflation pressures for the different tyre categories and sizes. The basic tyre and rim dimension nomenclature is explained below.

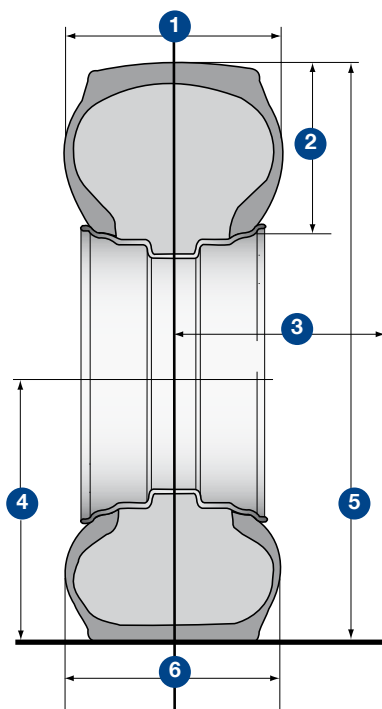

- 1 Section Width (SD)**  
The width of the inflated tyre section, excluding any lettering or decoration.
- 2 Section Height (SH)**  
The distance from the bead seat to the outer tread contour of the inflated tyre at centerline.
- 3 Minimum Dual Spacing**  
The minimum recommended distance between centerlines of dual mounted tyres to avoid kissing in the flex area.
- 4 Static Loaded Radius (SLR)**  
The standing height from the road surface to the axle center under nominal tyre load/inflation conditions.
- 5 Outside Diameter (OD)**  
The diameter of an unloaded tyre, mounted on its recommended rim and inflated to recommended pressure.
- 6 Loaded Section Width (LSW)**  
The width of the loaded cross-section.

### Aspect Ratio

The section height (SH) expressed as a percentage of the section width (SD).

# Tyre markings

## Size markings

There are various forms of tyre size marking and these differ in order to differentiate between tyre types. The size markings should be treated the same as a part number on a vehicle, so the motorist should ensure that the tyres on his vehicle carry the precise markings indicated in the vehicle handbook or are an approved alternative fitment.

## Service description

In accordance with the European regulation (ECE-R54), all tyres intended for commercial vehicles will be marked with a “Service Description” located near to the tyre size marking. This consists of a code which indicates operating limits of load and speed and includes a “load index” for single and dual tyre fitment and a “speed symbol” (e.g. 156/150 L).

An additional marking may be used to show the corresponding tyre loads for an alternative higher speed or for an alternative higher load. This additional marking will be placed in a circle.

## Free Rolling Tyre (FRT)

‘FRT’ stands for ‘Free Rolling Tyre’ and is a legal marking according to the UNECE Regulation No. 54, which indicates that the tyre is specifically designed and intended for the equipment of trailer axles and axles of motor vehicles other than front steering and all drive axles.

Therefore these trailer tyres marked ‘FRT’ should be used exclusively on trailer axles and axles of motor vehicles other than front steering and all drive axles and should not be fitted in any other position.

Goodyear will not warrant and cannot be held accountable for any potential liability claim involving FRT tyres fitted outside these recommendations.



## Winter tyre markings: M+S and 3PMSF



**M+S** (also M.S. or M&S) has been the widely used marking on winter tyres, stipulated in EU legislation.<sup>1</sup>

On 1 November 2012 Regulation 117 made a new marking official in the EU – the “Alpine” symbol, or the three-peak-mountain with snowflake (“3PMSF”). Unlike the M+S marking, the 3PMSF can only be legally used if the tyre passes a minimum performance threshold requirement on snow, the so called “snow grip index”.

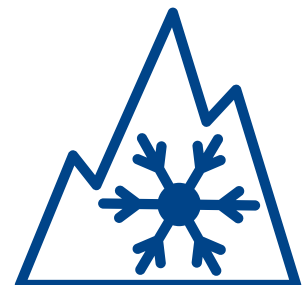

However, M+S remains as a permitted marking, but not legally linked to a minimum guaranteed performance in winter conditions. M+S tyres have better snow traction than regular tyres but do not necessarily pass the snow grip threshold legal requirement to qualify for the new three-peak snowflake identification.

<sup>1</sup> Council Directive 92/23/EEC of 31 March 1992 relating to tyres for motor vehicles and their trailers and to their fitting.



Most of Goodyear truck and bus tyres are marked with the **3PMSF** symbol.

**M+S**



---

## Size definitions

Listed below are the size designations that are being used on truck tyres. With each size is an explanation of what each component describes.

**12**

Section width  
in inches

/

**R**

R-radial

**22.5**

Rim diameter  
in inches

**152/148**

Load index  
(single/dual mounted)

**M**

Speed  
symbol

**295**

Section width  
in mm

/

**80**

Aspect  
ratio

**R**

R-radial

**22.5**

Rim diameter  
in inches

**152/148**

Load index  
(single/dual mounted)

**M**

Speed  
symbol

**365**

Section width  
in mm

/

**80**

Aspect  
ratio

**R**

R-radial

**20.0**

Rim diameter  
in inches

**160**

Load index  
(single mounted)

**J**

Speed  
symbol

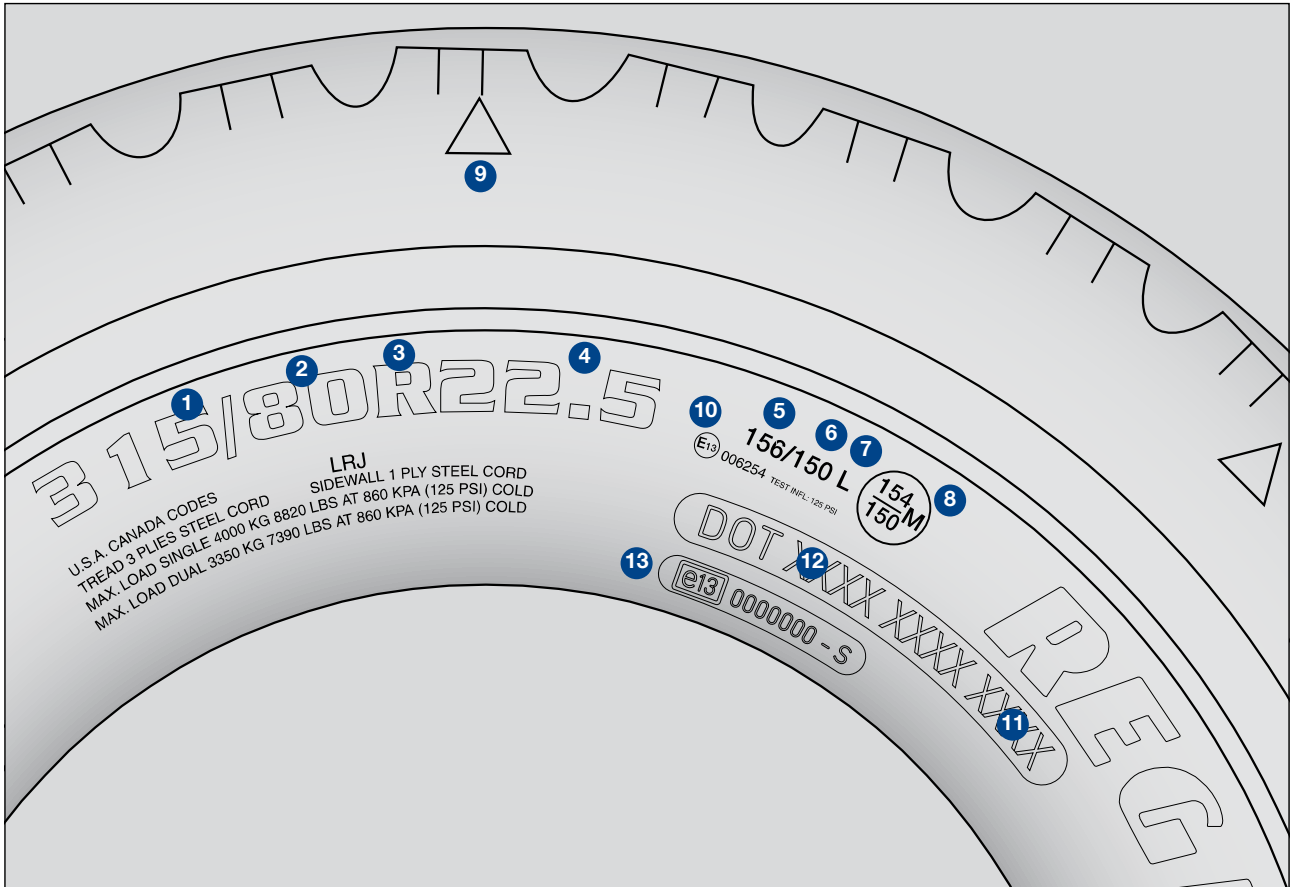

The position of the major tyre markings are as shown;

- 1 Tyre Section width (mm or inches)
- 2 Aspect ratio SH / SD
- 3 Radial construction (R=Radial)
- 4 Rim Diameter (inches)
- 5 Load Index (Max. load per tyre – single mounted)
- 6 Load Index (Max. load per tyre – dual mounted)
- 7 Speed Symbol
- 8 Alternative load indices when used with alternative speed
- 9 TWI – Tread Wear Indicator
- 10 ECE Homologation number
- 11 Date code (week, year)
- 12 DOT Manufacturing Code
- 13 Noise number – indicates that the tyre conforms to ECE noise regulations

**USA and Canada**

In accordance with US Safety Regulation MVSS 109 for car tyres, and 119 for truck tyres, the maximum load of the tyre in pounds (LBS) and its corresponding air pressure in pounds per square inch (PSI) must be shown on the tyre.

Additionally, the tyre must be marked D.O.T. (Department of Transportation) to insure that it conforms to all valid regulations in these countries.

# Load Index and Speed Symbol

These parameters are established by ETRTO and are the two most important service factors determining tyre performance.

Load indices and speed symbols are shown on both tyre sidewalls. Example: 149/145 L. The first number denotes the tyre load carrying capacity in SINGLE application, while the second number refers to DUAL fitment. The letter “L” defines the maximum speed limit. Unmarked Radial tyres are allowed up to a speed of 110 km/h. (Bias ply tyres are confined to 100 km/h).

Retreaded tyres can be run up to a maximum speed of 110 km/h, unless they are marked otherwise.

Special purpose tyres, for specific heavy duty applications must have the respective speed limitations identified on the sidewall.

The speed and load service identifications below are required by the European ECE-R54 regulation. The scale below shows the relationship between the Load Index (LI) and actual load values in kilograms [kg].

Load Index											
LI	kg	LI	kg	LI	kg	LI	kg	LI	kg	LI	kg
51	195	71	345	91	615	111	1090	131	1950	151	3450
52	200	72	355	92	630	112	1120	132	2000	152	3550
53	206	73	365	93	650	113	1150	133	2060	153	3650
54	212	74	375	94	670	114	1180	134	2120	154	3750
55	218	75	387	95	690	115	1215	135	2180	155	3875
56	224	76	400	96	710	116	1250	136	2240	156	4000
57	230	77	412	97	730	117	1285	137	2300	157	4125
58	236	78	425	98	750	118	1320	138	2360	158	4250
59	243	79	437	99	775	119	1360	139	2430	159	4375
60	250	80	450	100	800	120	1400	140	2500	160	4500
61	257	81	462	101	825	121	1450	141	2575	161	4625
62	265	82	475	102	850	122	1500	142	2650	162	4750
63	272	83	487	103	875	123	1550	143	2725	163	4875
64	280	84	500	104	900	124	1600	144	2800	164	5000
65	290	85	515	105	925	125	1650	145	2900	165	5150
66	300	86	530	106	950	126	1700	146	3000	166	5300
67	307	87	545	107	975	127	1750	147	3075	167	5450
68	315	88	560	108	1000	128	1800	148	3150	168	5600
69	325	89	580	109	1030	129	1850	149	3250	169	5800
70	335	90	600	110	1060	130	1900	150	3350	170	6000

The LOAD INDEX denotes the maximum load a given tyre can carry at the maximum speed as indicated by the speed symbol.

Speed symbol	Speed (km/h)
E	70
F	80
G	90
J	100
K	110
L	120
M	130
N	140

The SPEED SYMBOL denotes the maximum speed at which a given tyre can carry the load indicated by the load index.

# Interaction of Load and Speed

## Load Capacity Variations (%) as a function of Speed

Below information is based on the “European Tyre and Rim Technical Organization – Standards Manual” – Load Variation with Speed section.

Variations in Load Carrying Capacity with Speed (%)

Speed km/h	F 80 km/h	G 90 km/h	J 100 km/h	K 110 km/h	L 120 km/h	M 130 km/h	Inflation Pressure (%) <sup>*</sup> Compensation
Static	+150	+150	+150	+150	+150	+150	+40
5	+110	+110	+110	+110	+110	+110	+40
10	+80	+80	+80	+80	+80	+80	+30
15	+65	+65	+65	+65	+65	+65	+25
20	+50	+50	+50	+50	+50	+50	+21
25	+35	+35	+35	+35	+35	+35	+17
30	+25	+25	+25	+25	+25	+25	+13
35	+19	+19	+19	+19	+19	+19	+11
40	+15	+15	+15	+15	+15	+15	+10
45	+13	+13	+13	+13	+13	+13	+9
50	+12	+12	+12	+12	+12	+12	+8
55	+11	+11	+11	+11	+11	+11	+7
60	+10	+10	+10	+10	+10	+10	+6
65	+7.5	+8.5	+8.5	+8.5	+8.5	+8.5	+4
70	+5	+7	+7	+7	+7	+7	+2
75	+2.5	+5.5	+5.5	+5.5	+5.5	+5.5	+1
80	0	+4	+4	+4	+4	+4	0
85		2	+3	+3	+3	+3	0
90		0	+2	+2	+2	+2	0
95			+1	+1	+1	+1	0
100			0	0	0	0	0
105				0	0	0	0
110				0	0	0	0
115					0	0	0
120					0	0	0
125						0	0
130						0	0

NOTES: Increment to be applied in the absence of any specific agreement with the tyre manufacturer. These increments do only apply to the “nominal” load/speed indices.

## Notes concerning “Variations in load capacity with speed (%)”

(Below notes refer to the ETRTO (European Tyre and Rim Technical Organisation) Guidelines, in case more details are required, please refer to the actual valid ETRTO Standards Manual)

- For the application being considered, “SPEED” means:
  - either the maximum speed capability of the motor vehicle
  - or any overriding national requirement/legislation for the type of motor vehicle
  - or, in case of “special applications”, the specific conditions of use.
- The load carrying capacity of tyres in dual fitments is twice the load carrying capacity in single up to 40 km/h. Bonus loads will not be permitted for speeds of 40 km/h and above if the wheel axles are rigidly fixed to the body of vehicle.
- Bonus loads are not applicable for trailers and semi-trailers at speeds over 65 km/h.

- **General definitions**

Buses (Category M3 vehicles in the EU Directive) are subdivided into three classes depending on the intended type of use. Category M3 vehicles, for the carriage of passengers, have more than eight seats in addition to the driver’s seat and exceed 5 tonnes in overall weight.

**Class I**

Urban-bus or City bus – foreseen for urban use with frequent stops, these vehicles have spaces for standing passengers and allow movements of passengers.

**Class II**

Suburban bus or Interurban bus – foreseen for passenger transport within a given district, these vehicles have no specific spaces for standing passengers, but allow them to keep standing in the gangway for some distances during the trip.

**Class III**

Touring coach – These vehicles mainly foreseen for long distances, are conceived for transportation of sitting passengers only.

On the basis of the specific conditions of use of the buses designed for urban or suburban services and irrespective of their actual maximum speed capability, the following bonus loads apply:

**Class I**

+ 15% of the load indices marked on the tyre, when the average speed does not exceed 40 km/h.

**Class II**

+ 10% of the load indices marked on the tyre, when the operating speed is restricted to 60 km/h.

**Class III**

no bonus load Class

- For the equipment of special public service vehicles in urban and suburban applications (for instance road sweepers, fire tenders, etc.), on the basis of specific conditions of use and irrespective of the actual maximum speed capabilities of the vehicle, a bonus load of 10% applies with respect to the load indices marked on the tyre.
- In any case, it is recommended to avoid the maximum permissible load capacity if the resulting inflation pressure is higher than 1000 kPa. In that case, the load capacity shall be reduced accordingly.
- It is imperative to consult Rim/Wheel Manufacturers for the choice of rims and wheels suitable for the load carrying capacities and the inflation pressures required for applications at speeds of 40 km/h and below.

## Additional load/speed markings

The tyre manufacturer has the possibility to add to the “nominal” load/speed indices an additional load/speed index with different load index and different speed index. This additional load/speed index is circled.

For other load benefits due to maximum speed variations please consult the table and notes in the “Interaction of Load and Speed” section.

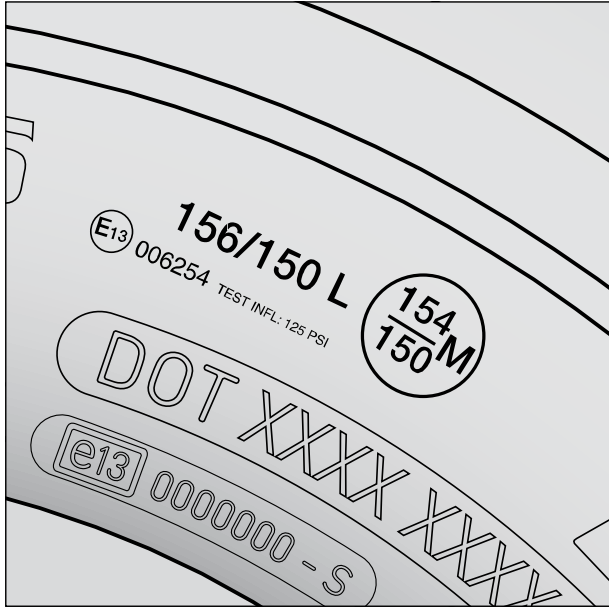

NOTES: ETRTO tables apply only to nominal LI/SI marking.

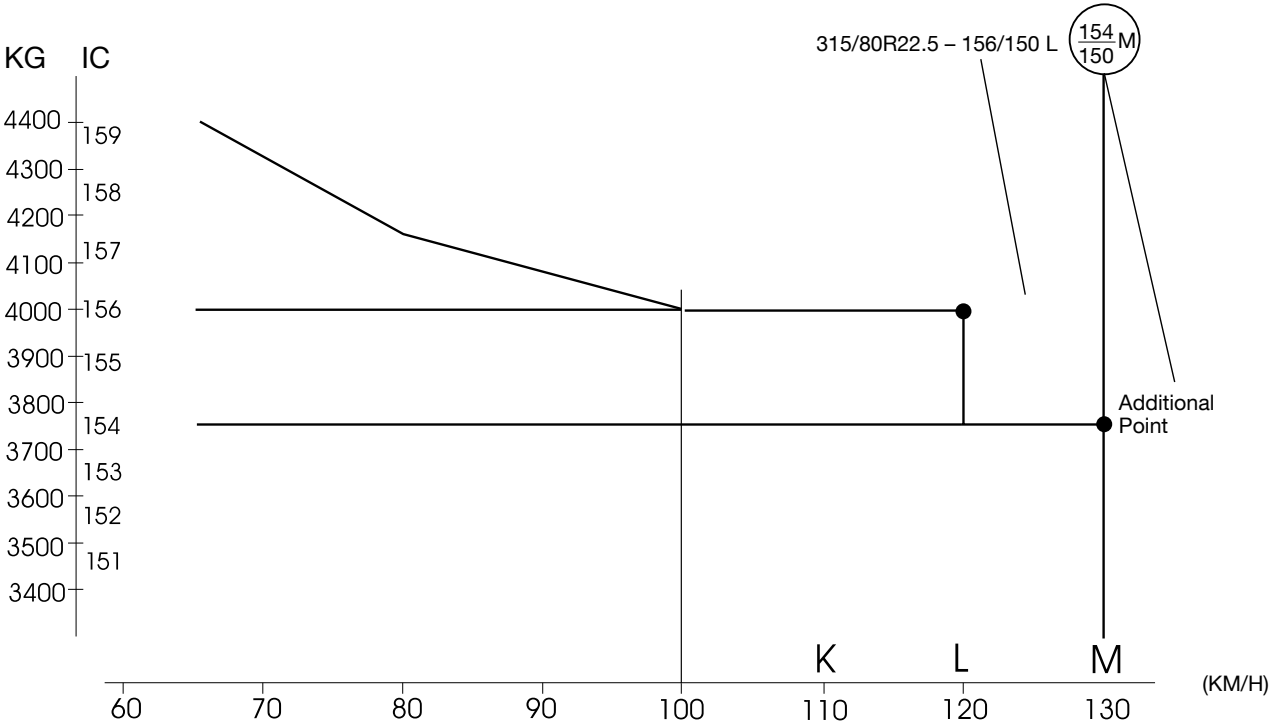

# Rims and Wheels

For truck tyres, there are essentially 3 basic rim types available on the market:

- one-piece tubeless drop center rims
- multi-piece tube-type flat base rims
- multi-piece tubeless flat base rims

## One-piece tubeless drop center

5° Drop center Rim – (13", 14", 17" etc...) symmetric and asymmetric rims for standard and low section light truck (C) tyres.

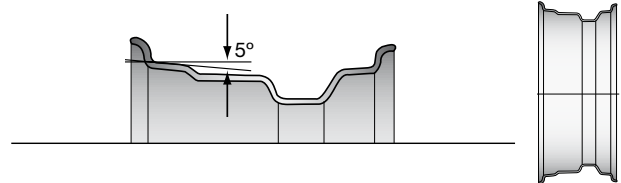

15° Drop center Rim – (17.5", 19.5", 22.5" etc...) rims for standard and wide section (Low Aspect Ratio, Super Single) tyres.

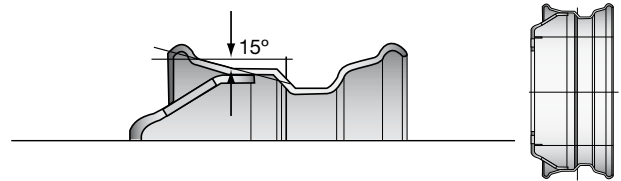

## Two and four-piece tube-type flat base

(Mainly 20") rims for high aspect ratio tyres. It will be important to avoid interchanging of parts from both systems.



NOTE: Each system is usually identified accordingly (stamped 2P or 4P).

## Two-piece tube-type flat base

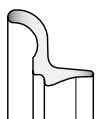

Combination Side Ring

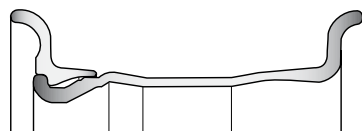

## Four-piece tube-type flat base



Lock ring



Side ring



Bead seat band



## Four-piece tube-type flat base



Lock ring



Side ring



Bead seat band

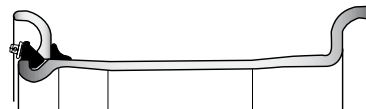

(20") rims for mainly 80-series tyres. They require a new sealing gasket for each new tyre.



Complete wheel details are shown below:

- 1 Drop center
- 2 Disc
- 3 Rim/disc junction
- 4 Hub contact face
- 5 Pitch (bolt) circle diameter
- 6 Offset
- 7 Center hole diameter
- 8 Stud hole diameter
- 9 Rim flange
- 10 Taper
- 11 Rim Width
- 12 Rim flange height
- 13 Rim flange width
- 14 Rim flange radius
- 15 Valve hole
- 16 Ball tape

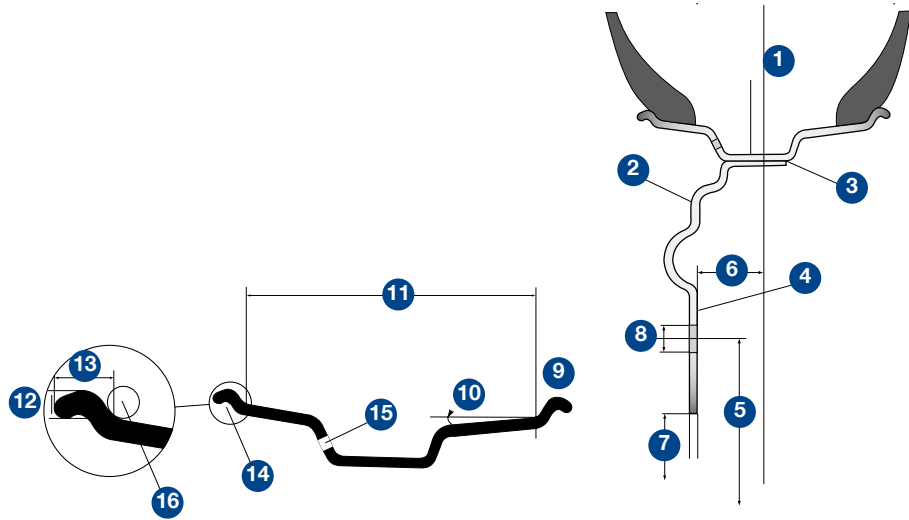

NOTE: Rim diameters can only be accurately measured by means of a special ball tape.

All wheels have a given offset (O) which does not only provide for the necessary brake drum space, but which also determines track width, kingpin offset, handling characteristics and wheel bearing load. On dual assemblies, it also influences the dual spacing.

Tyre fitters and mechanics must therefore pay attention that:

- specific vehicles are fitted with the correct offset wheels.
- wheels with different offsets are not mixed up on the same axle.

Wheel offsets can be positive, negative or zero. The offset is defined as the distance from the wheel center to the inside face of the disc (against the hub) and is called positive whenever this inside face is located outside of the centerline, negative when located inside, zero when matching the centerline exactly.

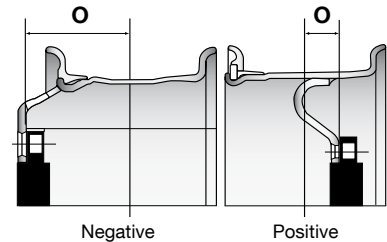

As a general maintenance rule, assembling and disassembling of multi-piece rims should only be done with specially designed tools. This will not only assure the safety of the fitter, but will also avoid usage of hammers and other inadequate equipment which could sooner or later damage or break vital rim parts. Also, for 1-piece tubeless rims, proper tooling is essential, since it will otherwise be extremely difficult or even impossible to mount such tyres safely and without bead area damage.

For demountable 1- or multiple-piece spoke-type wheels, the following additional precautions should be taken:

- Contact surfaces between rim and star should not be painted to guarantee perfected centring.
- Bolts should be tightened clockwise (not crosswise) – without exceeding the recommended maximum torque given by the vehicle manufacturer.
- Bolts and clamps should be re-checked at 50-100 km after wheel fitment and re-tightened if necessary.
- In case of dual mounting, the spacer ring should be pre-centered over the centering cams (placed on spokeheads).

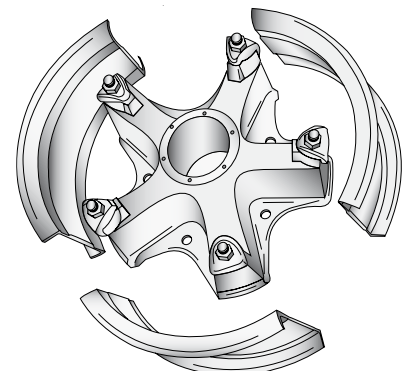

---

# Tubes and Flaps

Only use “Radial” marked tubes and flaps in Radial Tyres. Preferably fit a new tube and a new flap when mounting a new tyre. Due to their inherent construction, Radial Tyres impose far greater local stresses on Inner tubes than Bias Tyres. “Radial” marked Tubes are specially compounded to withstand these stresses and their use in Radial Tyres is mandatory. “Radial” marked Tubes may also be used in Bias Tyres, but in this application, unmarked Bias Tubes are perfectly satisfactory.

The higher stresses in Radial Tyres render the tube more susceptible to Flap Edge Cutting, and the use of “Radial” marked flaps, specially compounded such that they will not harden excessively in service is mandatory.

## Tubes

Tubes are designed within well defined limits of Radial and Total Stretch. A tube too large will be liable to buckling, and to early failure. A tube too small will be stretched excessively, leading to reduced rub resistance, and poorer air retention. In an emergency, a small tube is better than a large tube, since the failure mode is less likely to be catastrophic.

In case of necessity, a tube may be reused, if,

- There is no apparent damage and
- If the tube has not grown excessively during the first life. It is suggested that for a tube to be reused, a residual radial stretch of at least 15% is required.

NOTE: The fitment of tubes to “tubeless” tyres is not recommended.

## Flaps

The flap is designed to:

- Protect the tube from the roughness of the rim.
- To prevent the tube being pinched by the component parts of multi-pieced rims.
- To prevent the tube being pushed through the valve slot.

As a rule we can say that flaps are necessary for any rim which has a valve slot as against a valve hole.

All Drop center rims including passenger, truck and farm, have a valve hole on the side of the well and require an off center valve on the tube. They do not require a Flap.

Drop center truck rims occasionally have the valve hole on center, but these are normally only fitted with run out tubes in emergency cases which is a practice not endorsed by Goodyear.

All flat base rims with a removable flange have a valve slot extending from the centerline of the rim to the edge. These rims require a flap, and a tube with an on center valve.

All Semi Drop center rims have a short valve slot, which may be on or off center dependant on the type of rim, and upon the rim manufacturer, and require flaps and tubes with respectively on or off center valvehole, and tube valve.

## Rim slot cover plates

Even the best flaps, subjected as they are to high pressure and temperature, (wheel temperatures as high as 200°C have been measured on the inside rear position in City Bus service in Europe) are liable to be pushed through the rim slot in service.

Flaps are designed with fabric, or heavy rubber reinforcement in the valve slot area to overcome this problem, but for critical applications, the use of commercially available rim slot coverplates, or even a large diameter metal washer are recommended. Since the push through, and possible failure occurs next to the bead, rather than around the valve, bridge plates, are not really effective, and their use in Europe is decreasing.

## Medium truck – 20/24”

Tyre size	Tube	Rim	Flap
12.00R20	12.00R20	8.0	20R8.5
		8.5	20R8.5
		9.0	20R9.5
14.00R20	14.00R20	10.0	20R9.0
12.00R24	12.00R24	8.0	24R8.5
		8.5	24R8.5
		9.0	24R9.0

# Valves

Three types of Inner Tube Valve exist in Commercial service:

## Rubber covered valves

Rubber covered valves which may be rigid as for the TR15, or hand bendable as for the TR150.

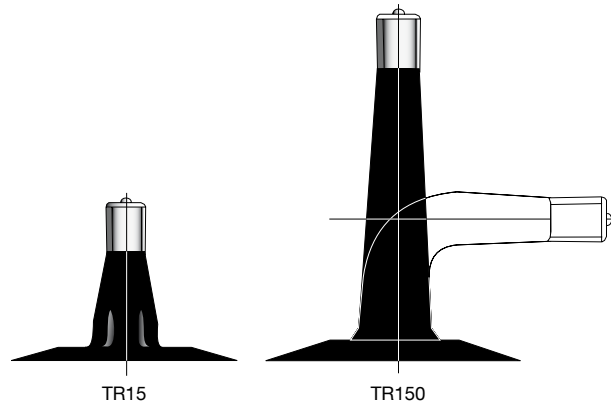

## One-piece metal valves

One-piece metal valves, such as the TR44 series. These are generally supplied with the required bent form, and may be single, double or triple bent.

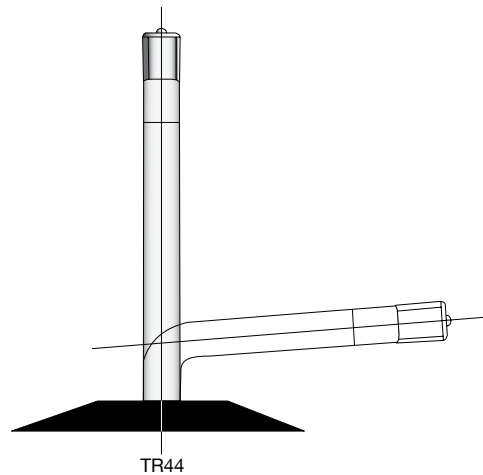

## Two-piece metal valves

European style two-piece metal valves consist of a spud (a short threaded metal tube) vulcanised onto the tube and a pre-bent extension which screws onto the spud, using a rubber washer as the air seal.

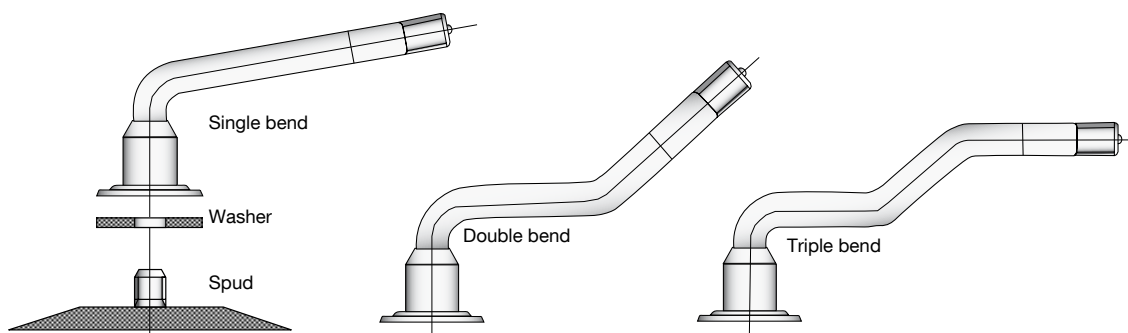

## Fitting extension valves

Extensions are actually coded in the form V\*-\*\*-\*\*, but to avoid confusion are generally referred to as the designation of the one piece metal valve to which they are equivalent.

The weakest part of the design of the extension type valves is the rubber washer. The washer is compressed when the valve is tightened, and loses its elasticity with age. Rubber washers should never be reused since they harden and take a permanent set. Similarly, extensions should never be backed off to make them line up with the rim slots.

The correct procedure is to wind the extension onto the stem until it just contacts the washer. Take another half turn. Then mount the tyre/tube/flap assembly, and line the extension up with the slot by tightening further.

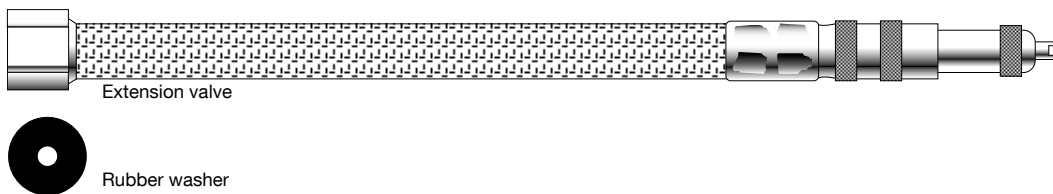

## Valve caps

Valves must always be fitted with a valve cap.

The valve core is present to allow the internal air pressure to be measured and changed. It is the valve cap which is the primary air seal. Valve caps are always made of metal and have a rubber sealing ring. The plastic dust caps are not suitable for field service. They are designed to prevent damage to the Tube/Valve/Valve Core during transportation from point of manufacture to point of use.

## Valve cores

Valve cores are available in two lengths, two temperature ranges, and with either internal or external springs. Fortunately all these cores are interchangeable. It is recommended to use the short core, internal spring, heat resistant type. These are recognisable since the small rubber collar around the core is coloured red.

## Conversion from T&RA to reference numbers

T&RA	Single	ETRTO Double	Triple
TR75	V3.02.27		
TR76	V3.02.8		
TR78	V3.02.12	V3.04.6	V3.06.5
TR175	V3.02.10	V3.04.4	V3.06.3
TR177	V3.02.9	V3.04.3/10	V3.06.1
TR178	V3.02.14		
TR179	V3.02.15		V3.06.6
TR285			V3.07.1

NOTE: Goodyear primarily manufactures truck tubes with spud/screw on extension type valves.





**Goodyear Dunlop Tires  
Operations S.A.**

Av. Gordon Smith  
L-7750 Colmar-Berg

**Telephone**

(352) 8199-1

**Telefax**

(352) 8199 2175

Contact your local Goodyear dealer for tyre availability

NOTE: Whilst every care has been taken in the production of this publication, no responsibility can be accepted for any loss or damage arising out of undetected errors or mis-printing which may have occurred.

All information in this material was valid on its date of issuance (May 2020).  
For detailed and up to date information, please refer to your dealer or to [www.goodyear.eu](http://www.goodyear.eu)

Produced by  
Goodyear Dunlop Tires Operations S.A.  
0520/LUX-ENG



[www.goodyear.eu/truck](http://www.goodyear.eu/truck)